

# TDS2000C and TDS1000C-EDU Series Digital Storage Oscilloscopes

## User Manual



071-2722-03

**Tektronix**



**TDS2000C and TDS1000C-EDU Series  
Digital Storage Oscilloscopes  
User Manual**

Revision A

[www.tektronix.com](http://www.tektronix.com)

071-2722-03

**Tektronix**

Copyright © Tektronix. All rights reserved. Licensed software products are owned by Tektronix or its subsidiaries or suppliers, and are protected by national copyright laws and international treaty provisions.

Tektronix products are covered by U.S. and foreign patents, issued and pending. Information in this publication supersedes that in all previously published material. Specifications and price change privileges reserved.

TEKTRONIX and TEK are registered trademarks of Tektronix, Inc.

OpenChoice™ is a registered trademark of Tektronix, Inc.

PictBridge is a registered trademark of the Standard of Camera & Imaging Products Association CIPA DC-001-2003 Digital Photo Solutions for Imaging Devices.

## **Contacting Tektronix**

Tektronix, Inc.  
14150 SW Karl Braun Drive  
P.O. Box 500  
Beaverton, OR 97077  
USA

For product information, sales, service, and technical support:

- In North America, call 1-800-833-9200.
- Worldwide, visit [www.tektronix.com](http://www.tektronix.com) to find contacts in your area.

### Limited Lifetime Warranty

Tektronix warrants to the original end user purchaser (“original purchaser”) of the product listed below that the product will be free from defects in materials and workmanship for the lifetime of the product. **As used herein, “lifetime of the product” is defined as a period ending five (5) years after Tektronix discontinues manufacturing the product (as determined by Tektronix), but the warranty period shall be at least ten (10) years from the date of purchase of the product by the original purchaser from Tektronix or an authorized Tektronix distributor. This limited lifetime warranty only applies to the original purchaser and is not transferable.** In the event of a warranty claim under the limited lifetime warranty, the purchaser must provide satisfactory evidence of the date of purchase from Tektronix or an authorized Tektronix distributor and that it is the original purchaser. In the event of the sale or other transfer of the product by the original purchaser to a third party within three (3) years of the date of purchase of the product by the original purchaser, the warranty period shall be three (3) years from the date of purchase of the product by the original purchaser from Tektronix or an authorized Tektronix distributor. Probes and other accessories and batteries and fuses are not covered by this warranty.

If the product proves defective during the applicable warranty period, Tektronix, at its option, either will repair the defective product without charge for parts and labor, or will provide a replacement of an equivalent product (as determined by Tektronix) in exchange for the defective product. Parts, modules and replacement products used by Tektronix for warranty work may be new or reconditioned to like new performance. All replaced parts, modules and products become the property of Tektronix.

As used hereafter, “Customer” refers to the person or entity asserting rights under this warranty. In order to obtain service under this warranty, Customer must notify Tektronix of the defect before the expiration of the applicable warranty period and make suitable arrangements for the performance of service. Customer shall be responsible for packaging and shipping the defective product to the service center designated by Tektronix, shipping charges prepaid and with a copy of proof of purchase by the original purchaser. Tektronix shall pay for the return of the product to Customer if the shipment is to a location within the country in which the Tektronix service center is located. Customer shall be responsible for paying all shipping charges, duties, taxes, and any other charges for products returned to any other locations.

This warranty shall not apply to any defect, failure or damage caused by accident, ordinary wear and tear of mechanical components, use outside of the product’s specifications, improper use or improper or inadequate maintenance and care. Tektronix shall not be obligated to furnish service under this warranty a) to repair damage resulting from attempts by personnel other than Tektronix representatives to install, repair or service the product; b) to repair damage resulting from improper use or connection to incompatible equipment; c) to repair any damage or malfunction caused by the use of non-Tektronix supplies; or d) to service a product that has been modified or integrated with other products when the effect of such modification or integration increases the time or difficulty of servicing the product.

THIS WARRANTY IS GIVEN BY TEKTRONIX WITH RESPECT TO THE PRODUCT IN LIEU OF ANY OTHER WARRANTIES, EXPRESS OR IMPLIED. TEKTRONIX AND ITS VENDORS DISCLAIM ANY IMPLIED WARRANTIES OF MERCHANTABILITY OR FITNESS FOR A PARTICULAR PURPOSE. TEKTRONIX’ RESPONSIBILITY TO REPAIR OR REPLACE DEFECTIVE PRODUCTS IS THE SOLE AND EXCLUSIVE REMEDY PROVIDED TO THE CUSTOMER FOR BREACH OF THIS WARRANTY. TEKTRONIX AND ITS VENDORS WILL NOT BE LIABLE FOR ANY INDIRECT, SPECIAL, INCIDENTAL, OR CONSEQUENTIAL DAMAGES IRRESPECTIVE OF WHETHER TEKTRONIX OR THE VENDOR HAS ADVANCE NOTICE OF THE POSSIBILITY OF SUCH DAMAGES.

## Warranty

Tektronix warrants that the product will be free from defects in materials and workmanship for a period of three (3) years from the date of original purchase from an authorized Tektronix distributor. If the product proves defective during this warranty period, Tektronix, at its option, either will repair the defective product without charge for parts and labor, or will provide a replacement in exchange for the defective product. Batteries are excluded from this warranty. Parts, modules and replacement products used by Tektronix for warranty work may be new or reconditioned to like new performance. All replaced parts, modules and products become the property of Tektronix.

In order to obtain service under this warranty, Customer must notify Tektronix of the defect before the expiration of the warranty period and make suitable arrangements for the performance of service. Customer shall be responsible for packaging and shipping the defective product to the service center designated by Tektronix, shipping charges prepaid, and with a copy of customer proof of purchase. Tektronix shall pay for the return of the product to Customer if the shipment is to a location within the country in which the Tektronix service center is located. Customer shall be responsible for paying all shipping charges, duties, taxes, and any other charges for products returned to any other locations.

This warranty shall not apply to any defect, failure or damage caused by improper use or improper or inadequate maintenance and care. Tektronix shall not be obligated to furnish service under this warranty a) to repair damage resulting from attempts by personnel other than Tektronix representatives to install, repair or service the product; b) to repair damage resulting from improper use or connection to incompatible equipment; c) to repair any damage or malfunction caused by the use of non-Tektronix supplies; or d) to service a product that has been modified or integrated with other products when the effect of such modification or integration increases the time or difficulty of servicing the product.

THIS WARRANTY IS GIVEN BY TEKTRONIX WITH RESPECT TO THE PRODUCT IN LIEU OF ANY OTHER WARRANTIES, EXPRESS OR IMPLIED. TEKTRONIX AND ITS VENDORS DISCLAIM ANY IMPLIED WARRANTIES OF MERCHANTABILITY OR FITNESS FOR A PARTICULAR PURPOSE. TEKTRONIX' RESPONSIBILITY TO REPAIR OR REPLACE DEFECTIVE PRODUCTS IS THE SOLE AND EXCLUSIVE REMEDY PROVIDED TO THE CUSTOMER FOR BREACH OF THIS WARRANTY. TEKTRONIX AND ITS VENDORS WILL NOT BE LIABLE FOR ANY INDIRECT, SPECIAL, INCIDENTAL, OR CONSEQUENTIAL DAMAGES IRRESPECTIVE OF WHETHER TEKTRONIX OR THE VENDOR HAS ADVANCE NOTICE OF THE POSSIBILITY OF SUCH DAMAGES.

[W16 – 15AUG04]

## Warranty

Tektronix warrants that this product will be free from defects in materials and workmanship for a period of one (1) year from the date of shipment. If any such product proves defective during this warranty period, Tektronix, at its option, either will repair the defective product without charge for parts and labor, or will provide a replacement in exchange for the defective product. Parts, modules and replacement products used by Tektronix for warranty work may be new or reconditioned to like new performance. All replaced parts, modules and products become the property of Tektronix.

In order to obtain service under this warranty, Customer must notify Tektronix of the defect before the expiration of the warranty period and make suitable arrangements for the performance of service. Customer shall be responsible for packaging and shipping the defective product to the service center designated by Tektronix, with shipping charges prepaid. Tektronix shall pay for the return of the product to Customer if the shipment is to a location within the country in which the Tektronix service center is located. Customer shall be responsible for paying all shipping charges, duties, taxes, and any other charges for products returned to any other locations.

This warranty shall not apply to any defect, failure or damage caused by improper use or improper or inadequate maintenance and care. Tektronix shall not be obligated to furnish service under this warranty a) to repair damage resulting from attempts by personnel other than Tektronix representatives to install, repair or service the product; b) to repair damage resulting from improper use or connection to incompatible equipment; c) to repair any damage or malfunction caused by the use of non-Tektronix supplies; or d) to service a product that has been modified or integrated with other products when the effect of such modification or integration increases the time or difficulty of servicing the product.

THIS WARRANTY IS GIVEN BY TEKTRONIX WITH RESPECT TO THE PRODUCT IN LIEU OF ANY OTHER WARRANTIES, EXPRESS OR IMPLIED. TEKTRONIX AND ITS VENDORS DISCLAIM ANY IMPLIED WARRANTIES OF MERCHANTABILITY OR FITNESS FOR A PARTICULAR PURPOSE. TEKTRONIX' RESPONSIBILITY TO REPAIR OR REPLACE DEFECTIVE PRODUCTS IS THE SOLE AND EXCLUSIVE REMEDY PROVIDED TO THE CUSTOMER FOR BREACH OF THIS WARRANTY. TEKTRONIX AND ITS VENDORS WILL NOT BE LIABLE FOR ANY INDIRECT, SPECIAL, INCIDENTAL, OR CONSEQUENTIAL DAMAGES IRRESPECTIVE OF WHETHER TEKTRONIX OR THE VENDOR HAS ADVANCE NOTICE OF THE POSSIBILITY OF SUCH DAMAGES.

[W2 – 15AUG04]





---

# Table of Contents

General Safety Summary .....	iv
Compliance Information .....	vii
EMC Compliance .....	vii
Safety Compliance .....	ix
Environmental Considerations .....	xi
Preface .....	xiii
Help System .....	xiv
Firmware Updates Through the Internet .....	xv
Conventions .....	xvi
Getting Started .....	1
General Features .....	1
Installation .....	2
Functional Check .....	4
Probe Safety .....	5
Voltage Probe Check Wizard .....	5
Manual Probe Compensation .....	7
Probe Attenuation Setting .....	7
Current Probe Scaling .....	8
Self Calibration .....	8
Operating Basics .....	9
Display Area .....	9
Using the Menu System .....	12
Vertical Controls .....	13
Horizontal Controls .....	14
Trigger Controls .....	15
Menu and Control Buttons .....	15
Input Connectors .....	18
Other Front-Panel Items .....	18
Understanding Oscilloscope Functions .....	19
Setting Up the Oscilloscope .....	19
Triggering .....	20
Acquiring Signals .....	22
Scaling and Positioning Waveforms .....	23
Taking Measurements .....	25
Application Examples .....	29
Taking Simple Measurements .....	30
Using Autorange to Examine a Series of Test Points .....	35
Taking Cursor Measurements .....	36
Analyzing Signal Detail .....	40

Capturing a Single-Shot Signal .....	41
Measuring Propagation Delay .....	43
Triggering on a Specific Pulse Width.....	44
Triggering on a Video Signal.....	45
Analyzing a Differential Communication Signal.....	49
Viewing Impedance Changes in a Network.....	50
Data Logging (not available on TDS1000C-EDU models) .....	52
Limit Testing (not available on TDS1000C-EDU models) .....	53
Math FFT .....	55
Setting Up the Time-Domain Waveform.....	55
Displaying the FFT Spectrum .....	57
Selecting an FFT Window .....	58
Magnifying and Positioning an FFT Spectrum.....	61
Measuring an FFT Spectrum Using Cursors.....	62
USB Flash Drive and Device Ports.....	63
USB Flash Drive Port .....	63
File Management Conventions.....	64
Saving and Recalling Files With a USB Flash Drive.....	65
Using the Save Function of the Print Front Panel Button .....	67
USB Device Port.....	69
Installing the PC Communications Software on a PC .....	70
Connecting to a PC .....	70
Connecting to a GPIB System.....	72
Command Entry.....	72
Connecting to a Printer.....	73
Printing a Screen Image.....	73
Reference .....	75
Acquire.....	75
Autorange.....	77
Autoset .....	79
Cursor .....	82
Default Setup.....	83
Display .....	83
Help .....	86
Horizontal.....	86
Math .....	87
Measure .....	89
Print .....	90
Probe Check .....	91
Reference Menu.....	91
Save/Recall .....	91

---

Trigger Controls.....	96
Utility .....	101
Vertical Controls .....	104
Appendix A: Specifications .....	107
Oscilloscope Specifications.....	107
Appendix B: TPP0101 and TPP0201 Series 10X Passive Probes Information.....	115
Connecting the Probe to the Oscilloscope .....	115
Compensating the Probe .....	115
Connecting the Probe to the Circuit .....	116
Standard Accessories .....	117
Optional Accessories .....	118
Specifications.....	118
Performance Graphs.....	119
Safety Summary .....	120
Appendix C: Accessories .....	123
Appendix D: Cleaning .....	125
General Care .....	125
Cleaning .....	125
Appendix E: Default Setup .....	127
Appendix F: Font Licenses .....	129
Index	

## General Safety Summary

Review the following safety precautions to avoid injury and prevent damage to this product or any products connected to it.

To avoid potential hazards, use this product only as specified.

*Only qualified personnel should perform service procedures.*

### To Avoid Fire or Personal Injury

**Use proper power cord.** Use only the power cord specified for this product and certified for the country of use.

**Connect and disconnect properly.** Connect the probe output to the measurement instrument before connecting the probe to the circuit under test. Connect the probe reference lead to the circuit under test before connecting the probe input. Disconnect the probe input and the probe reference lead from the circuit under test before disconnecting the probe from the measurement instrument.

**Ground the product.** This product is grounded through the grounding conductor of the power cord. To avoid electric shock, the grounding conductor must be connected to earth ground. Before making connections to the input or output terminals of the product, ensure that the product is properly grounded.

**Observe all terminal ratings.** To avoid fire or shock hazard, observe all ratings and markings on the product. Consult the product manual for further ratings information before making connections to the product.

Connect the probe reference lead to earth ground only.

Do not apply a potential to any terminal, including the common terminal, that exceeds the maximum rating of that terminal.

**Power disconnect.** The power switch disconnects the product from the power source. See instructions for the location. Do not block the power switch; it must remain accessible to the user at all times.

**Do not operate without covers.** Do not operate this product with covers or panels removed.

**Do not operate with suspected failures.** If you suspect that there is damage to this product, have it inspected by qualified service personnel.

**Avoid exposed circuitry.** Do not touch exposed connections and components when power is present.

**Do not operate in wet/damp conditions.**

**Do not operate in an explosive atmosphere.**

**Keep product surfaces clean and dry.**

**Provide proper ventilation.** Refer to the manual's installation instructions for details on installing the product so it has proper ventilation.

**Terms in This Manual** These terms may appear in this manual:



---

**WARNING.** *Warning statements identify conditions or practices that could result in injury or loss of life.*

---



---

**CAUTION.** *Caution statements identify conditions or practices that could result in damage to this product or other property.*

---

**Symbols and Terms on the Product**

These terms may appear on the product:

- DANGER indicates an injury hazard immediately accessible as you read the marking.
- WARNING indicates an injury hazard not immediately accessible as you read the marking.
- CAUTION indicates a hazard to property including the product.

The following symbol(s) may appear on the product:

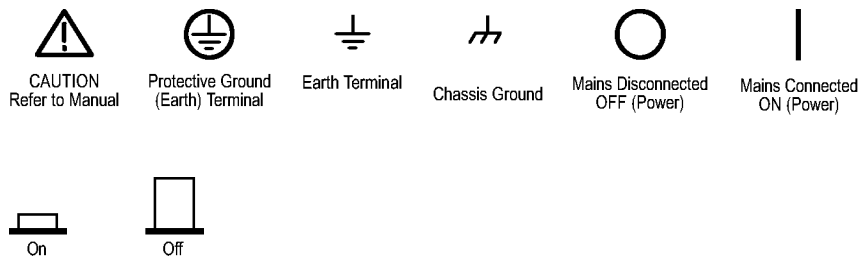

# Compliance Information

This section lists the EMC (electromagnetic compliance), safety, and environmental standards with which the instrument complies.

## EMC Compliance

### EC Declaration of Conformity – EMC

Meets intent of Directive 2004/108/EC for Electromagnetic Compatibility. Compliance was demonstrated to the following specifications as listed in the Official Journal of the European Communities:

**EN 61326-1:2006, EN 61326-2-1:2006.** EMC requirements for electrical equipment for measurement, control, and laboratory use.<sup>1 2 3</sup>

- CISPR 11:2003. Radiated and conducted emissions, Group 1, Class A
- IEC 61000-4-2:2001. Electrostatic discharge immunity
- IEC 61000-4-3:2002. RF electromagnetic field immunity<sup>4</sup>
- IEC 61000-4-4:2004. Electrical fast transient/burst immunity
- IEC 61000-4-5:2001. Power line surge immunity
- IEC 61000-4-6:2003. Conducted RF immunity<sup>5</sup>
- IEC 61000-4-11:2004. Voltage dips and interruptions immunity<sup>6</sup>

**EN 61000-3-2:2006.** AC power line harmonic emissions

**EN 61000-3-3:1995.** Voltage changes, fluctuations, and flicker

### European Contact.

Tektronix UK, Ltd.  
Western Peninsula  
Western Road  
Bracknell, RG12 1RF  
United Kingdom

- <sup>1</sup> This product is intended for use in nonresidential areas only. Use in residential areas may cause electromagnetic interference.
- <sup>2</sup> Emissions which exceed the levels required by this standard may occur when this equipment is connected to a test object.
- <sup>3</sup> To ensure compliance with the EMC standards listed here, high quality shielded interface cables should be used.
- <sup>4</sup> The instrument will exhibit  $\leq 1.0$  division waveform displacement and  $\leq 2.0$  division increase in peak-to-peak noise when subjected to radiated interference per IEC 61000-4-3.
- <sup>5</sup> The instrument will exhibit  $\leq 0.5$  division waveform displacement and  $\leq 1.0$  division increase in peak-to-peak noise when subjected to conducted interference per IEC 61000-4-6.
- <sup>6</sup> Performance Criterion C applied at the 70%/25 cycle Voltage-Dip and the 0%/250 cycle Voltage-Interruption test levels (IEC 61000-4-11). If the instrument powers down upon a voltage dip or interruption, it will take longer than ten seconds to return to the previous operating state.

**Australia / New Zealand  
Declaration of  
Conformity – EMC**

Complies with the EMC provision of the Radiocommunications Act per the following standard, in accordance with ACMA:

- CISPR 11:2003. Radiated and Conducted Emissions, Group 1, Class A, in accordance with EN 61326-1:2006 and EN 61326-2-1:2006.



## Safety Compliance

### EC Declaration of Conformity – Low Voltage

Compliance was demonstrated to the following specification as listed in the Official Journal of the European Communities:

Low Voltage Directive 2006/95/EC.

- EN 61010-1: 2001. Safety requirements for electrical equipment for measurement control and laboratory use.

### U.S. Nationally Recognized Testing Laboratory Listing

- UL 61010-1:2004, 2<sup>nd</sup> Edition. Standard for electrical measuring and test equipment.

### Canadian Certification

- CAN/CSA-C22.2 No. 61010-1:2004. Safety requirements for electrical equipment for measurement, control, and laboratory use. Part 1.

### Additional Compliances

- IEC 61010-1: 2001. Safety requirements for electrical equipment for measurement, control, and laboratory use.

### Equipment Type

Test and measuring equipment.

### Safety Class

Class 1 – grounded product.

### Pollution Degree Description

A measure of the contaminants that could occur in the environment around and within a product. Typically the internal environment inside a product is considered to be the same as the external. Products should be used only in the environment for which they are rated.

- Pollution Degree 1. No pollution or only dry, nonconductive pollution occurs. Products in this category are generally encapsulated, hermetically sealed, or located in clean rooms.
- Pollution Degree 2. Normally only dry, nonconductive pollution occurs. Occasionally a temporary conductivity that is caused by condensation must be expected. This location is a typical office/home environment. Temporary condensation occurs only when the product is out of service.
- Pollution Degree 3. Conductive pollution, or dry, nonconductive pollution that becomes conductive due to condensation. These are sheltered locations where neither temperature nor humidity is controlled. The area is protected from direct sunshine, rain, or direct wind.
- Pollution Degree 4. Pollution that generates persistent conductivity through conductive dust, rain, or snow. Typical outdoor locations.

**Installation (Overvoltage)  
Category Descriptions**

Terminals on this product may have different installation (overvoltage) category designations. The installation categories are:

- Measurement Category IV. For measurements performed at the source of low-voltage installation.
- Measurement Category III. For measurements performed in the building installation.
- Measurement Category II. For measurements performed on circuits directly connected to the low-voltage installation.
- Measurement Category I. For measurements performed on circuits not directly connected to MAINS.

**Overvoltage Category**

Overvoltage Category II (as defined in IEC 61010-1).

## Environmental Considerations

This section provides information about the environmental impact of the product.

### Product End-of-Life Handling

Observe the following guidelines when recycling an instrument or component:

**Equipment Recycling.** Production of this equipment required the extraction and use of natural resources. The equipment may contain substances that could be harmful to the environment or human health if improperly handled at the product's end of life. In order to avoid release of such substances into the environment and to reduce the use of natural resources, we encourage you to recycle this product in an appropriate system that will ensure that most of the materials are reused or recycled appropriately.



This symbol indicates that this product complies with the applicable European Union requirements according to Directives 2002/96/EC and 2006/66/EC on waste electrical and electronic equipment (WEEE) and batteries. For information about recycling options, check the Support/Service section of the Tektronix Web site ([www.tektronix.com](http://www.tektronix.com)).

### Restriction of Hazardous Substances

This product has been classified as Monitoring and Control equipment, and is outside the scope of the 2002/95/EC RoHS Directive.



# Preface

This manual contains operating information for the TDS2000C and TDS1000C-EDU Series Digital Storage Oscilloscopes. The manual consists of the following chapters:

- The *Getting Started* chapter briefly describes features of the oscilloscope and provides installation instructions.
- The *Operating Basics* chapter covers operating principles of the oscilloscopes.
- The *Understanding Oscilloscope Functions* chapter describes basic operations and functions of an oscilloscope: setting up the oscilloscope, triggering, acquiring data, scaling and positioning waveforms, and taking measurements.
- The *Application Examples* chapter provides examples on how to solve a variety of measurement problems.
- The *Math FFT* chapter describes how to use the Math Fast Fourier Transform function to convert a time-domain signal into its frequency components (spectrum).
- The *USB Flash Drive and Device Ports* chapter describes how to use the USB Flash Drive port and how to connect the oscilloscope to printers and computers through the USB Device port.
- The *Reference* chapter describes the selections or available range of values for each option.
- The *Appendix A: Specifications* chapter includes electrical, environmental, and physical specifications for the oscilloscope and the TPP0101 and TPP0201 probes, as well as certifications and compliances.
- The *Appendix B: Accessories* chapter briefly describes standard and optional accessories.
- The *Appendix C: Cleaning* chapter describes how to take care of the oscilloscope.
- The *Appendix D: Default Setup* chapter contains a list of the menus and controls with the default (factory) settings that are recalled when you push the **Default Setup** front-panel button.
- The *Appendix E: Font Licenses* chapter provides the licenses to use specific Asian fonts.

## Help System

The oscilloscope has a Help system with topics that cover all the features of the oscilloscope. You can use the Help system to display several kinds of information:

- General information about understanding and using the oscilloscope, such as Using the Menu System.
- Information about specific menus and controls, such as the Vertical Position Control.
- Advice about problems you may face while using an oscilloscope, such as Reducing Noise.

The Help system provides several ways to find the information you need: context-sensitive help, hyperlinks, and an index.

### Context-Sensitive Help

The oscilloscope displays information about the last menu displayed on the screen when you push the **Help** front-panel button. When viewing help topics, an LED lights next to the multipurpose knob to indicate that the knob is active. If the topic uses more than one page, turn the multipurpose knob to move from page to page within the topic.

### Hyperlinks

Most of the help topics contain phrases marked with angle brackets, such as <Autoset>. These are links to other topics. Turn the multipurpose knob to move the highlight from one link to another. Push the Show Topic option button to display the topic corresponding to the highlighted link. Push the Back option button to return to the previous topic.

### Index

Push the front-panel **Help** button, then push the Index option button. Push the Page Up or Page Down option buttons until you find the index page that contains the topic you want to view. Turn the multipurpose knob to highlight a help topic. Push the Show Topic option button to display the topic.

---

**NOTE.** Push the Exit option button or any menu button to remove the Help text from the screen and return to displaying waveforms.

---

## Firmware Updates Through the Internet

If a newer version of firmware becomes available, you can use the Internet and a USB flash drive to update your oscilloscope. If you do not have access to the Internet, contact Tektronix for information on update procedures.

To update the firmware from the Internet, follow these steps:

1. Push the **Utility ► System Status** option, and write down the firmware version number of the oscilloscope.
2. From your computer, access the [www.tektronix.com](http://www.tektronix.com) web site and check if a newer version of oscilloscope firmware is available.
3. If there is a newer version of firmware, download the firmware file from the web page.

You may need to unzip the downloaded file.

4. Copy the firmware file to the root folder of a USB flash drive.
5. Insert the USB flash drive into the USB Flash Drive port on the front of the oscilloscope.
6. From your oscilloscope, push the **Utility ► File Utilities ► - more - page 2 of 2 ► Update Firmware** option button.

It takes several minutes to update the firmware.

Your oscilloscope will prompt you to press a button when the firmware update is complete. You must not remove the USB flash drive, or power off the oscilloscope until the firmware update is complete.

## Conventions

This manual uses the following conventions:

- Menu options appear with the first letter of each word in upper case. For example: Peak Detect, Window Zone.

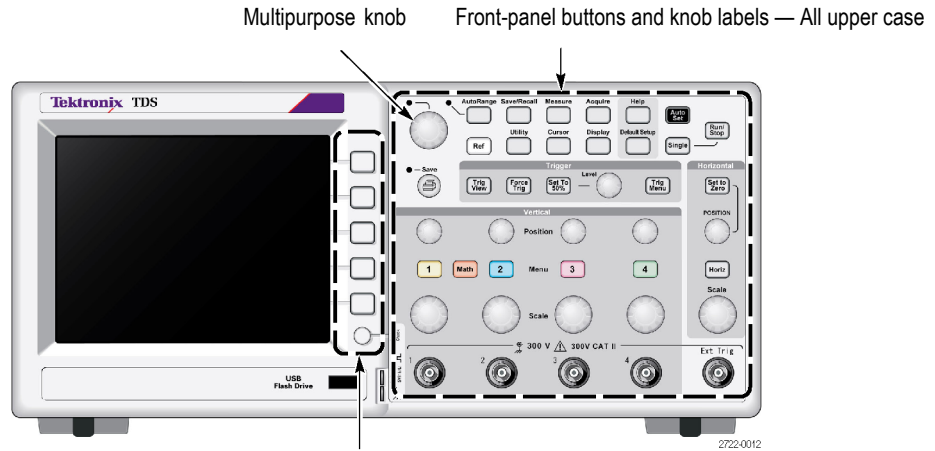

---

**NOTE.** Option buttons may also be called screen buttons, side-menu buttons, bezel buttons, or soft keys.

---

- The ► delimiter separates a series of button pushes. For example, **Utility ► Options ► Set Date and Time** means that you push the **Utility** front-panel button, then push the Options option button, and then push the Set Date and Time option button. Multiple pushes of an option button may be required to select the desired option.



# Getting Started

TDS2000C and TDS1000C-EDU Series Digital Storage Oscilloscopes are small, lightweight, benchtop instruments, which you can use to take ground-referenced measurements.

This chapter describes how to do the following tasks:

- Install your product
- Perform a brief functional check
- Perform a probe check and compensate probes
- Match your probe attenuation factor
- Use the self calibration routine

---

**NOTE.** You can select a language to display on the screen when you power on the oscilloscope. At any time, you can also access the **Utility ► Language** option to select a language.

---

## General Features

The next table and list describe the general features.

Model	Channels	Bandwidth	Sample rate	Display
TDS1001C-EDU	2	40 MHz	500 MS/s	Color
TDS1002C-EDU	2	60 MHz	1 GS/s	Color
TDS1012C-EDU	2	100 MHz	1 GS/s	Color
TDS2001C	2	50 MHz	500 MS/s	Color
TDS2002C	2	70 MHz	1.0 GS/s	Color
TDS2004C	4	70 MHz	1.0 GS/s	Color
TDS2012C	2	100 MHz	2.0 GS/s	Color
TDS2014C	4	100 MHz	2.0 GS/s	Color
TDS2022C	2	200 MHz	2.0 GS/s	Color
TDS2024C	4	200 MHz	2.0 GS/s	Color

- Context-sensitive help system
- Color LCD display
- Selectable 20 MHz bandwidth limit
- 2500 point record length for each channel
- Autoset
- Autoranging

- Probe Check Wizard
- Setup and waveform storage
- USB Flash Drive port for file storage
- Direct printing to any PictBridge compatible printer
- PC communications through the USB Device port with OpenChoice PC Communications software
- Connect to a GPIB controller through an optional TEK-USB-488 adapter
- Cursors with readouts
- Trigger frequency readout
- Sixteen automatic measurements
- Waveform averaging and peak detection
- Dual time base
- Math functions: +, -, and  $\times$  operations
- Math Fast Fourier Transform (FFT)
- Pulse Width trigger capability
- Video trigger capability with line-selectable triggering
- External trigger
- Variable persistence display
- User interface and help topics in ten languages

## Installation

- |                      |   |
|----------------------|---|
| <b>Power Cord</b>    | Use only the power cord provided with your oscilloscope. <i>Appendix B: Accessories</i> lists the standard and the optional accessories.                                      |
| <b>Power Source</b>  | Use a power source that delivers 90 to 264 VAC <sub>RMS</sub> , 45 to 66 Hz. If you have a 400 Hz power source, it must deliver 90 to 132 VAC <sub>RMS</sub> , 360 to 440 Hz. |
| <b>Security Loop</b> | Use a standard laptop computer security lock, or thread a security cable through the built-in cable channel to secure your oscilloscope to your location.                     |

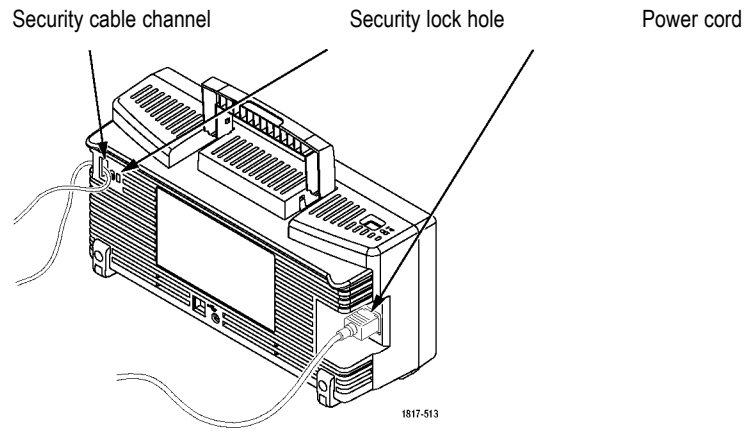

**Ventilation**

---

**NOTE.** *The oscilloscope cools by convection. Keep two inches clear on the sides and top of the product to allow adequate air flow.*

---

## Functional Check

Perform this functional check to verify that your oscilloscope is operating correctly.

---

ON/OFF button

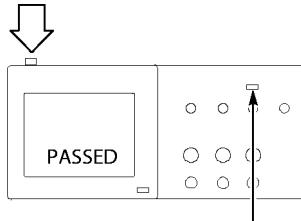

1. Power on the oscilloscope.  
Push the **Default Setup** button.  
The default Probe option attenuation setting is 10X.

Default Setup button

---

PROBE COMP

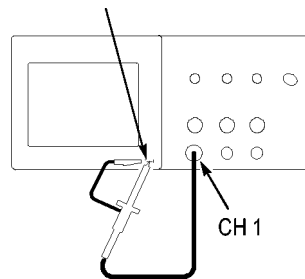

2. Connect the TPP0101/TP0201 probe to channel 1 on the oscilloscope. To do this, align the slot in the probe connector with the key on the CH 1 BNC, push to connect, and twist to the right to lock the probe in place.  
Connect the probe tip and reference lead to the PROBE COMP terminals.

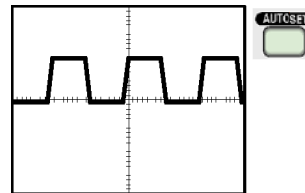

3. Push the **AutoSet** button. Within a few seconds, you should see a square wave in the display of about 5V peak-to-peak at 1 kHz.  
Push the **1** channel 1 menu button on the front panel twice to remove channel 1, push the **2** channel 2 menu button to display channel 2, and repeat steps 2 and 3. For 4-channel models, repeat for **3** and **4**.
-

## Probe Safety

Check and observe probe ratings before using probes.

A guard around the TPP0101/TPP0201 probe body provides a finger barrier for protection from electric shock.

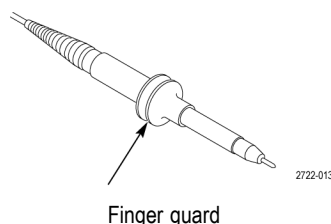

**WARNING.** To avoid electric shock when using the probe, keep fingers behind the guard on the probe body.

To avoid electric shock while using the probe, do not touch metallic portions of the probe head while it is connected to a voltage source.

Connect the probe to the oscilloscope, and connect the ground terminal to ground before you take any measurements.

## Voltage Probe Check Wizard

You can use the Probe Check Wizard to verify that a voltage probe is operating properly. The wizard does not support current probes.

The wizard helps you adjust the compensation for voltage probes (usually with a screw on the probe body or probe connector) and set the factor for the Attenuation option for each channel, such as in the **1 ► Probe ► Voltage ► Attenuation** option.

You should use the Probe Check Wizard each time you connect a voltage probe to an input channel.

To use the Probe Check Wizard, push the **PROBE CHECK** button. If the voltage probe is connected properly, compensated properly, and the Attenuation option in the oscilloscope Vertical menu is set to match the probe, the oscilloscope displays a PASSED message at the bottom of the screen. Otherwise, the oscilloscope displays directions on the screen to guide you in correcting these problems.

---

**NOTE.** *The Probe Check Wizard is useful for 1X, 10X, 20X, 50X, and 100X probes. It is not useful for 500X or 1000X probes, or for probes connected to the Ext Trig BNC.*

---

---

**NOTE.** *When the process is complete, the Probe Check Wizard restores the oscilloscope settings (other than the Probe option) to what they were before you pushed the PROBE CHECK button.*

---

To compensate a probe that you plan to use with the Ext Trig input, follow these steps:

1. Connect the probe to any input channel BNC, such as to channel **1**.
2. Push the **PROBE CHECK** button and follow the directions on the screen.
3. After you verify that the probe functions and is compensated properly, connect the probe to the Ext Trig BNC.

## Manual Probe Compensation

As an alternative method to the Probe Check Wizard, you can manually perform this adjustment to match your probe to the input channel.

---

PROBE COMP      AutoSet  
button

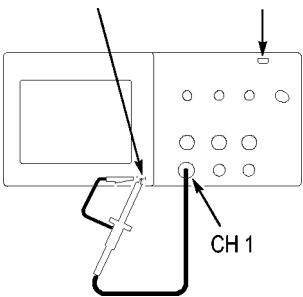

1. Push the **1 ▶ Probe ▶ Voltage ▶ Attenuation** option and select **10X**. Connect the TPP0101/TPP0201 probe to channel 1 on the oscilloscope. If you use the probe hook-tip, ensure a proper connection by firmly inserting the tip onto the probe.
2. Attach the probe tip to the PROBE COMP ~5V@1kHz terminal and the reference lead to the PROBE COMP chassis terminal. Display the channel, and then push the **AutoSet** button.
3. Check the shape of the displayed waveform.

---

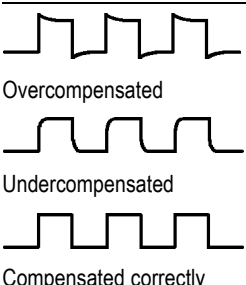

Overcompensated

Undercompensated

Compensated correctly

4. If necessary, adjust your probe. Repeat as necessary.

---

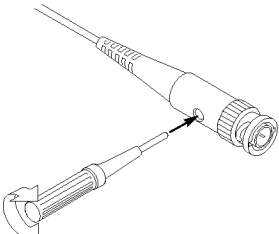

---

## Probe Attenuation Setting

Probes are available with various attenuation factors which affect the vertical scale of the signal. The Probe Check Wizard verifies that the attenuation factor in the oscilloscope matches the probe.

As an alternative method to Probe Check, you can manually select the factor that matches the attenuation of your probe. For example, to match a probe set to 10X connected to CH 1, push the **1 ▶ Probe ▶ Voltage ▶ Attenuation** option, and select **10X**.

---

**NOTE.** The default setting for the Attenuation option is 10X.

---

If you change the Attenuation switch on a P2220 probe, you also need to change the oscilloscope Attenuation option to match. Switch settings are 1X and 10X.

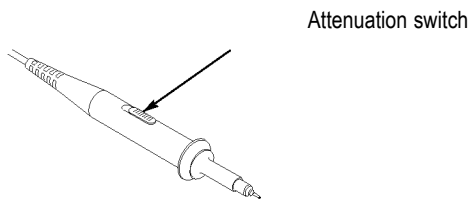

---

**NOTE.** When the Attenuation switch is set to 1X, the P2220 probe limits the bandwidth of the oscilloscope to 6 MHz. To use the full bandwidth of the oscilloscope, be sure to set the switch to 10X.

---

## Current Probe Scaling

Current probes provide a voltage signal proportional to the current. You need to set the oscilloscope to match the scale of your current probe. The default scale is 10 A/V.

For example, to set the scale for a current probe connected to CH 1, push the **1** ► **Probe** ► **Current** ► **Scale** option, and select an appropriate value.

## Self Calibration

The self calibration routine lets you optimize the oscilloscope signal path for maximum measurement accuracy. You can run the routine at any time but you should always run the routine if the ambient temperature changes by 5 °C (9 °F) or more. The routine takes about two minutes.

For accurate calibration, power on the oscilloscope and wait twenty minutes to ensure it is warmed up.

To compensate the signal path, disconnect any probes or cables from the input connectors. Then, access the **Utility** ► **Do Self Cal** option, and follow the directions on the screen.



# Operating Basics

The front panel is divided into easy-to-use functional areas. This chapter provides you with a quick overview of the controls and the information displayed on the screen.

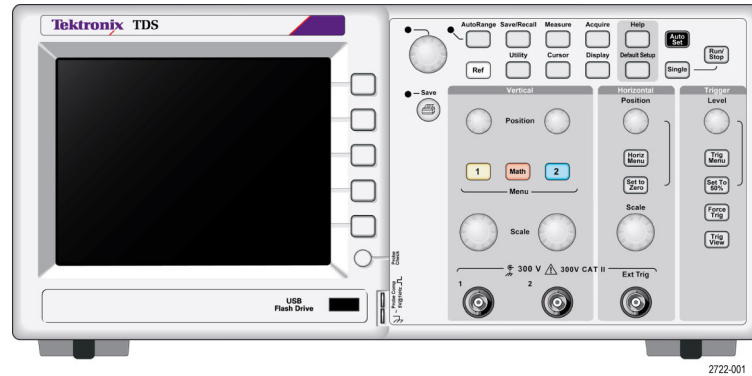

2-channel model

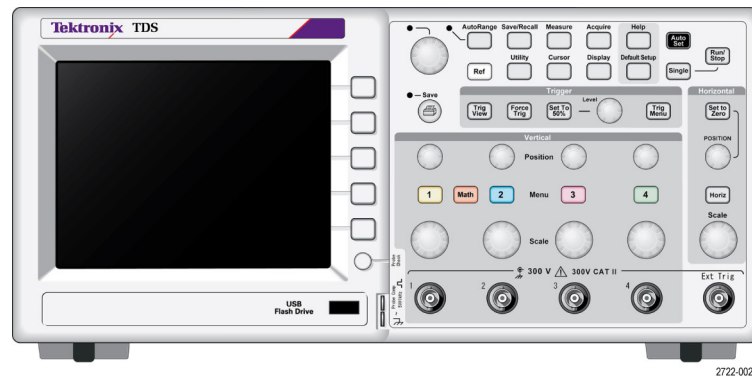

4-channel model

## Display Area

In addition to displaying waveforms, the display is filled with many details about the waveform and the oscilloscope control settings.

---

**NOTE.** For details on displaying the FFT function, (See page 57, *Displaying the FFT Spectrum.*)

---

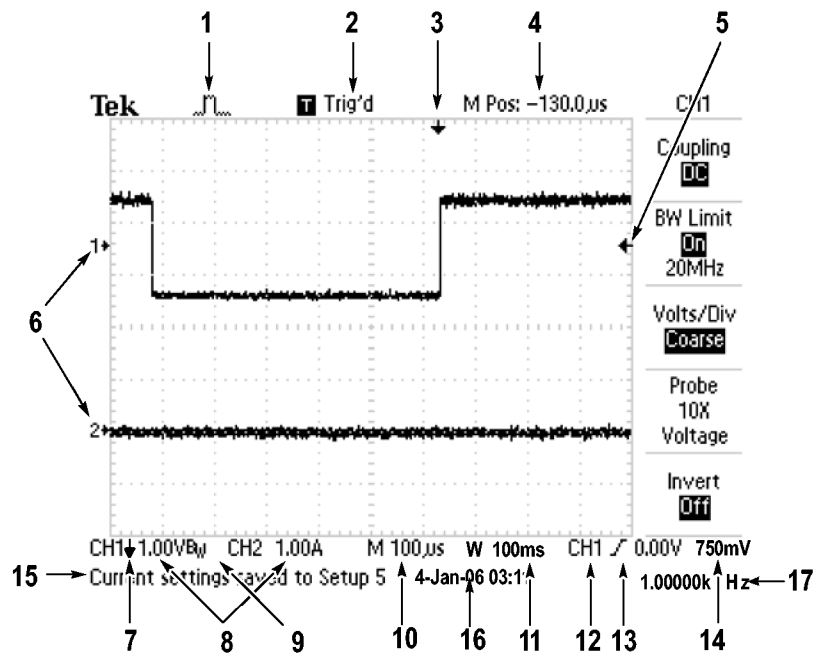

1. Icon display shows acquisition mode.



Sample mode



Peak detect mode



Average mode

2. Trigger status indicates the following:

<input type="checkbox"/> Armed.	The oscilloscope is acquiring pretrigger data. All triggers are ignored in this state.
<input checked="" type="checkbox"/> Ready.	All pretrigger data has been acquired and the oscilloscope is ready to accept a trigger.
<input checked="" type="checkbox"/> Trig'd.	The oscilloscope has seen a trigger and is acquiring the posttrigger data.
<input checked="" type="checkbox"/> Stop.	The oscilloscope has stopped acquiring waveform data.
<input checked="" type="checkbox"/> Acq. Complete	The oscilloscope has completed a Single Sequence acquisition.
<input checked="" type="checkbox"/> Auto.	The oscilloscope is in auto mode and is acquiring waveforms in the absence of triggers.
<input type="checkbox"/> Scan.	The oscilloscope is acquiring and displaying waveform data continuously in scan mode.

3. Marker shows horizontal trigger position. Turn the **Horizontal Position** knob to adjust the position of the marker.

4. Readout shows the time at the center graticule. The trigger time is zero.

5. Marker shows Edge or Pulse Width trigger level.

6. On-screen markers show the ground reference points of the displayed waveforms. If there is no marker, the channel is not displayed.

7. An arrow icon indicates that the waveform is inverted.

8. Readouts show the vertical scale factors of the channels.







9. A  $B_w$  icon indicates that the channel is bandwidth limited.

10. Readout shows main time base setting.

11. Readout shows window time base setting if it is in use.

12. Readout shows trigger source used for triggering.

13. Icon shows selected trigger type as follows:

	Edge trigger for the rising edge.
	Edge trigger for the falling edge.
	Video trigger for line sync.
	Video trigger for field sync.
	Pulse Width trigger, positive polarity.
	Pulse Width trigger, negative polarity.

- 14. Readout shows Edge or Pulse Width trigger level.
- 15. Display area shows helpful messages; some messages display for only three seconds.  
If you recall a saved waveform, readout shows information about the reference waveform, such as RefA 1.00V 500 $\mu$ s.
- 16. Readout shows date and time.
- 17. Readout shows trigger frequency.

### Message Area

The oscilloscope displays a message area (item number 15 in the previous figure) at the bottom of the screen that conveys the following types of helpful information:

- Directions to access another menu, such as when you push the **Trig Menu** button:  
For TRIGGER HOLDOFF, go to HORIZONTAL MENU
- Suggestion of what you might want to do next, such as when you push the **Measure** button:  
Push an option button to change its measurement
- Information about the action the oscilloscope performed, such as when you push the **Default Setup** button:  
Default setup recalled
- Information about the waveform, such as when you push the AutoSet button:  
Square wave or pulse detected on CH1

## Using the Menu System

The user interface of the oscilloscopes was designed for easy access to specialized functions through the menu structure.

When you push a front-panel button, the oscilloscope displays the corresponding menu on the right side of the screen. The menu shows the options that are available when you push the unlabeled option buttons directly to the right of the screen.

The oscilloscope uses several methods to display menu options:

- Page (Submenu) Selection: For some menus, you can use the top option button to choose two or three submenus. Each time you push the top button, the options change. For example, when you push the top button in the Trigger Menu, the oscilloscope cycles through the Edge, Video, and Pulse Width trigger submenus.
- Circular List: The oscilloscope sets the parameter to a different value each time you push the option button. For example, you can push the **1** (channel

1 menu) button and then push the top option button to cycle through the Vertical (channel) Coupling options.

In some lists, you can use the multipurpose knob to select an option. A hint line tells you when the multipurpose knob can be used, and an LED by the multipurpose knob lights when the knob is active. (See page 15, *Menu and Control Buttons*.)

- **Action:** The oscilloscope displays the type of action that will immediately occur when you push an Action option button. For example, when the Help Index is visible, and you push the Page Down option button, the oscilloscope immediately displays the next page of index entries.
- **Radio:** The oscilloscope uses a different button for each option. The currently-selected option is highlighted. For example, the oscilloscope displays various acquisition mode options when you push the Acquire Menu button. To select an option, push the corresponding button.

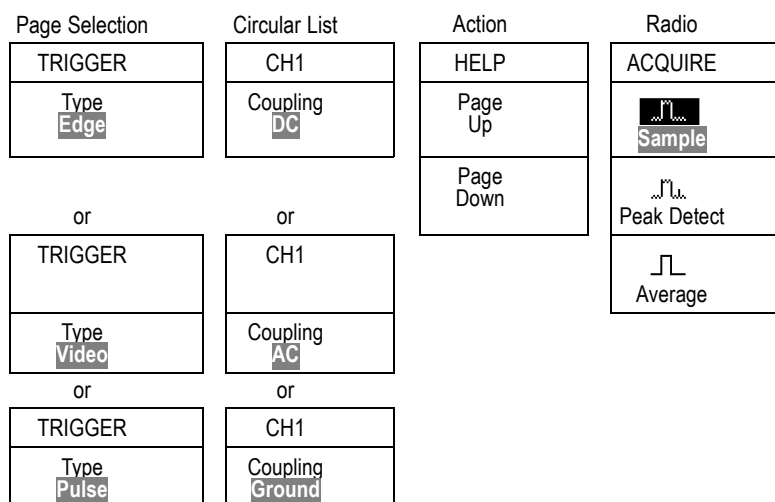

## Vertical Controls

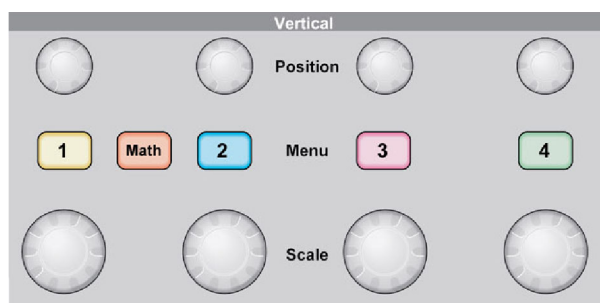

2722-000

All models, 4-channel shown

**Position (1, 2, 3 & 4).** Positions a waveform vertically.

**1, 2, 3 & 4 Menu.** Displays the Vertical menu selections and toggles the display of the channel waveform on and off.

**Scale (1, 2, 3 & 4).** Selects vertical scale factors.

**Math.** Displays waveform math operations menu and toggles the display of the math waveform on and off.

## Horizontal Controls

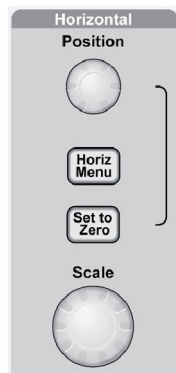

2722-004

2-channel model



2722-005

4-channel model

**Position.** Adjusts the horizontal position of all channel and math waveforms. The resolution of this control varies with the time base setting. (See page 87, *Window Zone*.)

---

**NOTE.** To make a large adjustment to the horizontal position, turn the **Horizontal Scale** knob to a larger value, change the horizontal position, and then turn the **Horizontal Scale** knob back to the previous value.

---

**Horiz.** Displays the Horizontal Menu.

**Set to Zero.** Sets the horizontal position to zero.

**Scale.** Selects the horizontal time/division (scale factor) for the main or the window time base. When Window Zone is enabled, it changes the width of the window zone by changing the window time base. (See page 87, *Window Zone*.)

## Trigger Controls

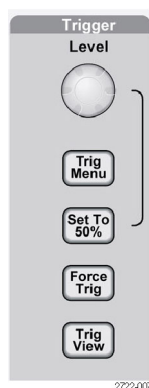

2-channel model

4-channel model



**Level.** When you use an Edge or Pulse trigger, the **Level** knob sets the amplitude level that the signal must cross to acquire a waveform.

**Trig Menu.** Displays the Trigger Menu.

**Set To 50%.** The trigger level is set to the vertical midpoint between the peaks of the trigger signal.

**Force Trig.** Completes an acquisition regardless of an adequate trigger signal. This button has no effect if the acquisition is already stopped.

**Trig View.** Displays the trigger waveform in place of the channel waveform while you hold down the **Trig View** button. Use this to see how the trigger settings affect the trigger signal, such as trigger coupling.

## Menu and Control Buttons

Multipurpose knob

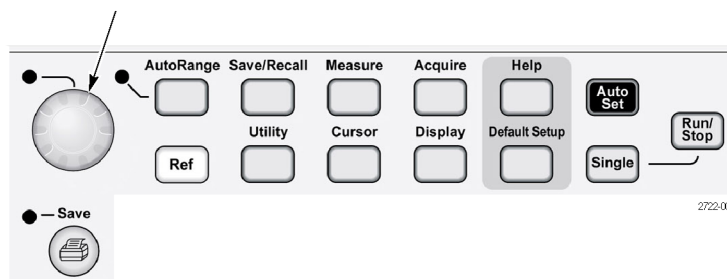

Refer to the *Reference* chapter for detailed information on the menu and button controls.

**Multipurpose Knob.** The function is determined by the displayed menu or selected menu option. When active, the adjacent LED lights. The next table lists the functions.

Active menu or option	Knob function	Description
Cursor	Cursor 1 or Cursor 2	Positions the selected cursor
Help	Scroll	Selects entries in the Index; selects links in a topic; displays the next or previous page for a topic
Horizontal	Holdoff	Sets the amount of time before another trigger event can be accepted; (See page 101, <i>Holdoff</i> .)
Math	Position	Positions the Math waveform
	Vertical Scale	Changes the scale of the Math waveform
Measure	Type	Selects the type of automatic measurement for each source
Save/Recall	Action	Sets the transaction as save or recall for setup files, waveform files, and screen images
	File selection	Selects setup, waveform, or image files to save, or selects setup or waveform files to recall
Trigger	Source	Selects the source when the Trigger Type option is set to Edge
	Video line number	Sets the oscilloscope to a specific line number when the Trigger Type option is set to Video and the Sync option is set to Line Number
	Pulse width	Sets the width of the pulse when the Trigger Type option is set to Pulse
Utility ► File Utilities	File selection	Selects files to rename or delete; (See page 103, <i>File Utilities for the USB Flash Drive</i> .)
	Name entry	Renames the file or folder; (See page 104, <i>Rename File or Folder</i> .)
Utility ► Options ► GPIB Setup ► Address	Value entry	Sets the GPIB address for the TEK-USB-488 adapter
Utility ► Options ► Set Date and Time	Value entry	Sets the value for the date and time; (See page 102, <i>Setting the Date and Time</i> .)



Active menu or option	Knob function	Description
Vertical ► Probe ► Voltage ► Attenuation	Value entry	For a channel menu (such as the CH 1 menu), sets the attenuation factor in the oscilloscope
Vertical ► Probe ► Current ► Scale	Value entry	For a of channel menu (such as the CH 1 menu), sets the scale in the oscilloscope

**AutoRange.** Displays the Autorange Menu, and activates or deactivates the autoranging function. When autoranging is active, the adjacent LED lights.

**Save/Recall.** Displays the Save/Recall Menu for setups and waveforms.

**Measure.** Displays the automated measurements menu.

**Acquire.** Displays the Acquire Menu.

**Ref.** Displays the Reference Menu to quickly display and hide reference waveforms stored in the oscilloscope non-volatile memory.

**Utility.** Displays the Utility Menu.

**Cursor.** Displays the Cursor Menu. Cursors remain visible (unless the Type option is set to Off) after you leave the Cursor Menu but are not adjustable.

**Display.** Displays the Display Menu.

**Help.** Displays the Help Menu.

**Default Setup.** Recalls the factory setup.

**AutoSet.** Automatically sets the oscilloscope controls to produce a usable display of the input signals.

**Single.** (Single sequence) Acquires a single waveform and then stops.

**Run/Stop.** Continuously acquires waveforms or stops the acquisition.

 Starts the print operation to a PictBridge compatible printer, or performs the Save function to the USB flash drive.

**Save.** An LED indicates when the print button is configured to save data to the USB flash drive.

## Input Connectors

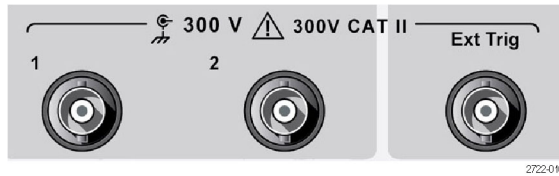

2-channel model



4-channel model

**1, 2, 3 & 4.** Input connectors for waveform display.

**Ext Trig.** Input connector for an external trigger source. Use the Trigger Menu to select the Ext, or Ext/5 trigger source. Push and hold the **Trig View** button to see how the trigger settings affect the trigger signal, such as trigger coupling.

## Other Front-Panel Items



USB Flash Drive port

**USB Flash Drive Port.** Insert a USB flash drive for data storage or retrieval. The oscilloscope displays a clock symbol to indicate when the flash drive is active. After a file is saved or retrieved, the oscilloscope removes the clock, and displays a hint line to notify you that the save or recall operation is complete.

For flash drives with an LED, the LED blinks when saving data to or retrieving data from the drive. Wait until the LED stops to remove the drive.

**PROBE COMP.** Probe compensation output and chassis reference. Use to electrically match a voltage probe to the oscilloscope input circuit. (See page 5, *Voltage Probe Check Wizard*.) (See page 7, *Manual Probe Compensation*.)

# Understanding Oscilloscope Functions

This chapter contains general information that you need to understand before you use an oscilloscope. To use your oscilloscope effectively, you need to learn about the following functions:

- Setting up the oscilloscope
- Triggering
- Acquiring signals (waveforms)
- Scaling and positioning waveforms
- Measuring waveforms

The next figure shows a block diagram of the various functions of the oscilloscope and their relationships to each other.

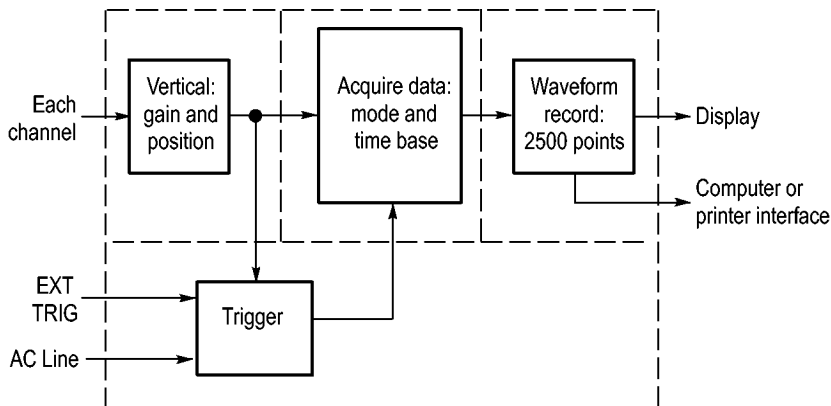

## Setting Up the Oscilloscope

You should become familiar with several functions that you may use often when operating your oscilloscope: Autoset, Autorange, saving a setup, and recalling a setup.

### Using Autoset

Each time you push the **AutoSet** button, the Autoset function obtains a stable waveform display for you. It automatically adjusts the vertical scale, horizontal scale and trigger settings. Autoset also displays several automatic measurements in the graticule area, depending on the signal type.

### Using Autorange

Autorange is a continuous function that you can enable or disable. The function adjusts setup values to track a signal when the signal exhibits large changes or when you physically move the probe to a different point.

**Saving a Setup** The oscilloscope saves the current setup if you wait five seconds after the last change before you power off the oscilloscope. The oscilloscope recalls this setup the next time you apply power.

You can use the Save/Recall Menu to save up to ten different setups.

You can also save setups to a USB flash drive. The oscilloscope accommodates a USB flash drive for removable data storage and retrieval. (See page 63, *USB Flash Drive Port*.)

**Recalling a Setup** The oscilloscope can recall the last setup before the oscilloscope was powered off, any saved setups, or the default setup. (See page 91, *Save/Recall*.)

**Default Setup** The oscilloscope is set up for normal operation when it is shipped from the factory. This is the default setup. To recall this setup, push the **Default Setup** button. To view the default settings, refer to *Appendix D: Default Setup*.

## Triggering

The trigger determines when the oscilloscope starts to acquire data and to display a waveform. When a trigger is set up properly, the oscilloscope converts unstable displays or blank screens into meaningful waveforms.

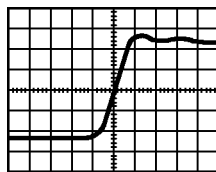

Triggered waveform

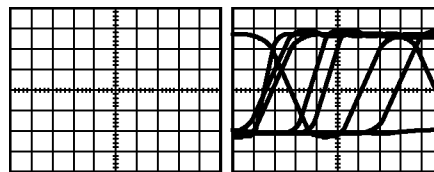

Untriggered waveforms

For oscilloscope-specific descriptions, refer to the *Operating Basics* chapter. (See page 15, *Trigger Controls*.) Refer also to the *Reference* chapter. (See page 96, *Trigger Controls*.)

When you push the **Run/Stop** or **Single** button to start an acquisition, the oscilloscope goes through the following steps:

1. Acquires enough data to fill the portion of the waveform record to the left of the trigger point. This is called the pretrigger.
2. Continues to acquire data while waiting for the trigger condition to occur.
3. Detects the trigger condition.

4. Continues to acquire data until the waveform record is full.
5. Displays the newly-acquired waveform.

---

**NOTE.** For Edge and Pulse triggers, the oscilloscope counts the rate at which trigger events occur to determine trigger frequency. The oscilloscope displays the frequency in the lower right corner of the screen.

---

**Source** You can use the Trigger Source options to select the signal that the oscilloscope uses as a trigger. The source can be the AC power line (available only with Edge triggers), or any signal connected to a channel BNC or to the Ext Trig BNC.

**Types** The oscilloscope provides three types of triggers: Edge, Video, and Pulse Width.

**Modes** You can select the Auto or the Normal trigger mode to define how the oscilloscope acquires data when it does not detect a trigger condition. (See page 96, *Mode Options*.)

To perform a single sequence acquisition, push the **Single** button.

**Coupling** You can use the Trigger Coupling option to determine which part of the signal will pass to the trigger circuit. This can help you attain a stable display of the waveform.

To use trigger coupling, push the **Trig Menu** button, select an Edge or Pulse trigger, and select a Coupling option.

---

**NOTE.** Trigger coupling affects only the signal passed to the trigger system. It does not affect the bandwidth or coupling of the signal displayed on the screen.

---

To view the conditioned signal being passed to the trigger circuit, push and hold down the **Trig View** button.

**Position** The horizontal position control establishes the time between the trigger and the screen center. Refer to *Horizontal Scale and Position; Pretrigger Information* for information on how to use this control to position the trigger. (See page 23, *Horizontal Scale and Position; Pretrigger Information*.)

**Slope and Level** The Slope and Level controls help to define the trigger. The Slope option (Edge trigger type only) determines whether the oscilloscope finds the trigger point on the rising or the falling edge of a signal. The **Trigger Level** knob controls where on the edge the trigger point occurs.

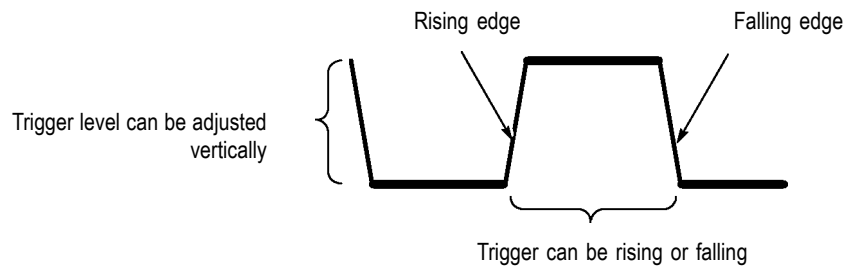

## Acquiring Signals

When you acquire a signal, the oscilloscope converts it into a digital form and displays a waveform. The acquisition mode defines how the signal is digitized, and the time base setting affects the time span and level of detail in the acquisition.

### Acquisition Modes

There are three acquisition modes: Sample, Peak Detect, and Average.

**Sample.** In this acquisition mode, the oscilloscope samples the signal in evenly spaced intervals to construct the waveform. This mode accurately represents signals most of the time.

However, this mode does not acquire rapid variations in the signal that may occur between samples. This can result in aliasing, and may cause narrow pulses to be missed. In these cases, you should use the Peak Detect mode to acquire data. (See page 23, *Time Domain Aliasing*.)

**Peak Detect.** In this acquisition mode, the oscilloscope finds the highest and lowest values of the input signal over each sample interval and uses these values to display the waveform. In this way, the oscilloscope can acquire and display narrow pulses, which may have otherwise been missed in Sample mode. Noise will appear to be higher in this mode.

**Average.** In this acquisition mode, the oscilloscope acquires several waveforms, averages them, and displays the resulting waveform. You can use this mode to reduce random noise.

### Time Base

The oscilloscope digitizes waveforms by acquiring the value of an input signal at discrete points. The time base allows you to control how often the values are digitized.

To adjust the time base to a horizontal scale that suits your purpose, use the **Horizontal Scale** knob.

## Scaling and Positioning Waveforms

You can change the display of waveforms by adjusting the scale and position. When you change the scale, the waveform display will increase or decrease in size. When you change the position, the waveform will move up, down, right, or left.

The channel indicator (located on the left of the graticule) identifies each waveform on the display. The indicator points to the ground reference level of the waveform record.

You can view the display area and readouts. (See page 9, *Display Area*.)

### Vertical Scale and Position

You can change the vertical position of waveforms by moving them up or down in the display. To compare data, you can align a waveform above another or you can align waveforms on top of each other.

You can change the vertical scale of a waveform. The waveform display will contract or expand relative to the ground reference level.

For oscilloscope-specific descriptions, refer to the *Operating Basics* chapter. (See page 13, *Vertical Controls*.) Refer also to the *Reference* chapter. (See page 104, *Vertical Controls*.)

### Horizontal Scale and Position; Pretrigger Information

You can adjust the **Horizontal Position** control to view waveform data before the trigger, after the trigger, or some of each. When you change the horizontal position of a waveform, you are actually changing the time between the trigger and the center of the display. (This appears to move the waveform to the right or left on the display.)

For example, if you want to find the cause of a glitch in your test circuit, you might trigger on the glitch and make the pretrigger period large enough to capture data before the glitch. You can then analyze the pretrigger data and perhaps find the cause of the glitch.

You change the horizontal scale of all the waveforms by turning the **Horizontal Scale** knob. For example, you might want to see just one cycle of a waveform to measure the overshoot on its rising edge.

The oscilloscope shows the horizontal scale as time per division in the scale readout. Since all active waveforms use the same time base, the oscilloscope only displays one value for all the active channels, except when you use Window Zone. Refer to *Window Zone* for information on how to use the window function. (See page 87, *Window Zone*.)

For oscilloscope-specific descriptions, refer to the *Operating Basics* chapter. (See page 14, *Position*.) Refer also to the *Reference* chapter. (See page 86, *Horizontal*.)

**Time Domain Aliasing.** Aliasing occurs when the oscilloscope does not sample the signal fast enough to construct an accurate waveform record. When this happens,

the oscilloscope displays a waveform with a frequency lower than the actual input waveform, or triggers and displays an unstable waveform.

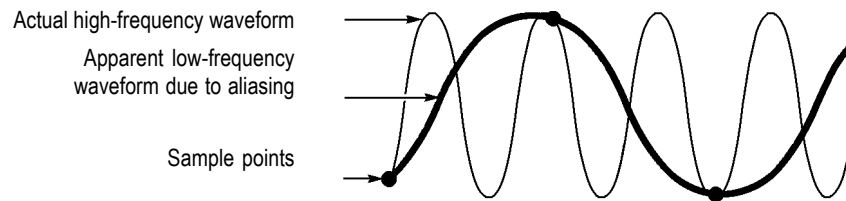

The oscilloscope accurately represents signals, but is limited by the probe bandwidth, the oscilloscope bandwidth, and the sample rate. To avoid aliasing, the oscilloscope must sample the signal more than twice as fast as the highest frequency component of the signal.

The highest frequency that the oscilloscope sampling rate can theoretically represent is the Nyquist frequency. The sample rate is called the Nyquist rate, and is twice the Nyquist frequency.

The oscilloscope maximum sample rates are at least ten times the bandwidth. These high sample rates help reduce the possibility of aliasing.

There are several ways to check for aliasing:

- Turn the horizontal **Scale** knob to change the horizontal scale. If the shape of the waveform changes drastically, you may have aliasing.
- Select the Peak Detect acquisition mode. (See page 22, *Peak Detect*.) This mode samples the highest and lowest values so that the oscilloscope can detect faster signals. If the shape of the waveform changes drastically, you may have aliasing.
- If the trigger frequency is faster than the display information, you may have aliasing or a waveform that crosses the trigger level multiple times. Examining the waveform allows you to identify whether the shape of the signal is going to allow a single trigger crossing per cycle at the selected trigger level.

If multiple triggers are likely to occur, select a trigger level that will generate only a single trigger per cycle. If the trigger frequency is still faster than the display indicates, you may have aliasing.

If the trigger frequency is slower, this test is not useful.

- If the signal you are viewing is also the trigger source, use the graticule or the cursors to estimate the frequency of the displayed waveform. Compare this to the Trigger Frequency readout in the lower right corner of the screen. If they differ by a large amount, you may have aliasing.

The next table lists the time base settings that you can use to avoid aliasing at various frequencies and the respective sample rate. At the fastest horizontal scale setting, aliasing is not likely to occur due to the bandwidth limitations of the oscilloscope input amplifiers.



**Settings to avoid aliasing in Sample mode**

Time base	Samples per second	Maximum
2.5 ns	2 GS/s	200.0 MHz †
5.0 to 250.0 ns	1 GS/s or 2 GS/s *	200.0 MHz †
500.0 ns	500.0 MS/s	200.0 MHz †
1.0 µs	250.0 MS/s	125.0 MHz †
2.5 µs	100.0 MS/s	50.0 MHz †
5.0 µs	50.0 MS/s	25.0 MHz †
10.0 µs	25.0 MS/s	12.5 MHz †
25.0 µs	10.0 MS/s	5.0 MHz
50.0 µs	5.0 MS/s	2.5 MHz
100.0 µs	2.5 MS/s	1.25 MHz
250.0 µs	1.0 MS/s	500.0 kHz
500.0 µs	500.0 kS/s	250.0 kHz
1.0 ms	250.0 kS/s	125.0 kHz
2.5 ms	100.0 kS/s	50.0 kHz
5.0 ms	50.0 kS/s	25.0 kHz
10.0 ms	25.0 kS/s	12.5 kHz
25.0 ms	10.0 kS/s	5.0 kHz
50.0 ms	5.0 kS/s	2.5 kHz
100.0 ms	2.5 kS/s	1.25 kHz
250.0 ms	1.0 kS/s	500.0 Hz
500.0 ms	500.0 S/s	250.0 Hz
1.0 s	250.0 S/s	125.0 Hz
2.5 s	100.0 S/s	50.0 Hz
5.0 s	50.0 S/s	25.0 Hz
10.0 s	25.0 S/s	12.5 Hz
25.0 s	10.0 S/s	5.0 Hz
50.0 s	5.0 S/s	2.5 Hz

\* Depending on the oscilloscope model.

† Bandwidth reduced to 6 MHz with a P2220 probe set to 1X.

## Taking Measurements

The oscilloscope displays graphs of voltage versus time and can help you to measure the displayed waveform.

There are several ways to take measurements. You can use the graticule, the cursors, or an automated measurement.

**Graticule** This method allows you to make a quick, visual estimate. For example, you might look at a waveform amplitude and determine that it is a little more than 100 mV.

You can take simple measurements by counting the major and minor graticule divisions involved and multiplying by the scale factor.

For example, if you counted five major vertical graticule divisions between the minimum and maximum values of a waveform and knew you had a scale factor of 100 mV/division, then you could calculate your peak-to-peak voltage as follows:

$$5 \text{ divisions} \times 100 \text{ mV/division} = 500 \text{ mV}$$

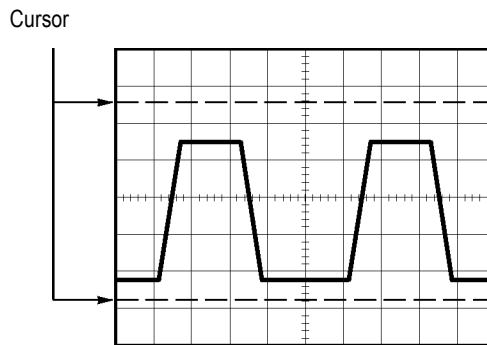

**Cursors** This method allows you to take measurements by moving the cursors, which always appear in pairs, and reading their numeric values from the display readouts. There are two types of cursors: Amplitude and Time.

When you use cursors, be sure to set the Source to the waveform on the display that you want to measure.

To use cursors, push the **Cursor** button.

**Amplitude Cursors.** Amplitude cursors appear as horizontal lines on the display and measure the vertical parameters. Amplitudes are referenced to the reference level. For the Math FFT function, these cursors measure magnitude.

**Time Cursors.** Time cursors appear as vertical lines on the display and measure both horizontal and vertical parameters. Times are referenced to the trigger point. For the Math FFT function, these cursors measure frequency.

Time cursors also include a readout of the waveform amplitude at the point the waveform crosses the cursor.

**Automatic** The Measure Menu can take up to five automatic measurements. When you take automatic measurements, the oscilloscope does all the calculating for you. Because the measurements use the waveform record points, they are more accurate than the graticule or cursor measurements.

Automatic measurements use readouts to show measurement results. These readouts are updated periodically as the oscilloscope acquires new data.

For measurement descriptions, refer to the *Reference* chapter. (See page 89, *Taking Measurements*.)



---

# Application Examples

This section presents a series of application examples. These simplified examples highlight the features of the oscilloscope and give you ideas for using it to solve your own test problems.

- Taking simple measurements

  - Using Autoset

  - Using the Measure Menu to take automatic measurements

  - Measuring two signals and calculating gain

- Using Autorange to examine a series of test points

- Taking cursor measurements

  - Measuring ring frequency and ring amplitude

  - Measuring pulse width

  - Measuring rise time

- Analyzing signal detail

  - Looking at a noisy signal

  - Using the average function to separate a signal from noise

- Capturing a single-shot signal

  - Optimizing the acquisition

- Measuring propagation delay

- Triggering on a pulse width

- Triggering on a video signal

  - Triggering on video fields and video lines

  - Using the window function to see waveform details

- Analyzing a differential communication signal using Math functions

- Viewing impedance changes in a network using XY mode and persistence

- Data logging (not available on TDS1000C-EDU models)

- Limit testing (not available on TDS1000C-EDU models)

## Taking Simple Measurements

You need to see a signal in a circuit, but you do not know the amplitude or frequency of the signal. You want to quickly display the signal and measure the frequency, period, and peak-to-peak amplitude.

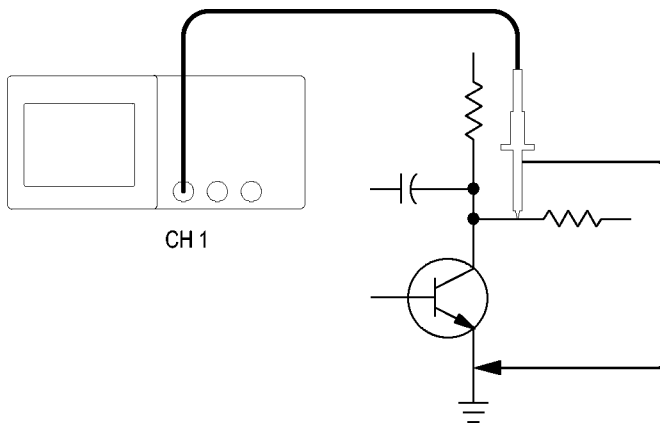

### Using Autoset

To quickly display a signal, follow these steps:

1. Push the **1** (channel 1 menu) button.
2. Push **Probe** ► **Voltage** ► **Attenuation** ► **10X**.
3. If using P2220 probes, set their switches to **10X**.
4. Connect the channel 1 probe tip to the signal. Connect the reference lead to the circuit reference point.
5. Push the **AutoSet** button.

The oscilloscope sets the vertical, horizontal, and trigger controls automatically. If you want to optimize the display of the waveform, you can manually adjust these controls.

---

**NOTE.** *The oscilloscope displays relevant automatic measurements in the waveform area of the screen based on the signal type that is detected.*

---

For oscilloscope-specific descriptions, refer to the *Reference* chapter. (See page 79, *Autoset*.)

## Taking Automatic Measurements

The oscilloscope can take automatic measurements of most displayed signals.

---

**NOTE.** *If a question mark (?) appears in the Value readout, the signal is outside the measurement range. Adjust the **Vertical Scale** knob (volts/division) of the appropriate channel to decrease the sensitivity or change the horizontal **Scale** setting (seconds/division).*

---

To measure signal frequency, period, and peak-to-peak amplitude, rise time, and positive width, follow these steps:

1. Push the **Measure** button to see the Measure Menu.

2. Push the top option button; the Measure 1 Menu appears.

3. Push **Type ► Freq.**

The **Value** readout displays the measurement and updates.

4. Push the **Back** option button.

5. Push the second option button from the top; the Measure 2 Menu appears.

6. Push **Type ► Period.**

The **Value** readout displays the measurement and updates.

7. Push the **Back** option button.

8. Push the middle option button; the Measure 3 Menu appears.

9. Push **Type ► Pk-Pk.**

The **Value** readout displays the measurement and updates.

10. Push the **Back** option button.

11. Push the second option button from the bottom; the Measure 4 Menu appears.

12. Push **Type ► Rise Time.**

The **Value** readout displays the measurement and updates.

13. Push the **Back** option button.

14. Push the bottom option button; the Measure 5 Menu appears.

15. Push **Type ► Pos Width.**

The **Value** readout displays the measurement and updates.

16. Push the **Back** option button.

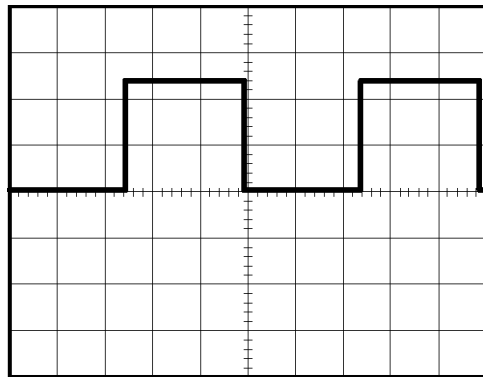

CH1  
Freq  
1.000kHz

CH1  
Period  
1.000ms

CH1  
Pk-Pk  
5.04V

CH1  
Rise Time  
2.611 $\mu$ s?

CH1  
Pos Width  
500.0 $\mu$ s



## Measuring Two Signals

If you are testing a piece of equipment and need to measure the gain of the audio amplifier, you will need an audio generator that can inject a test signal at the amplifier input. Connect two oscilloscope channels to the amplifier input and output as shown next. Measure both signal levels and use the measurements to calculate the gain.

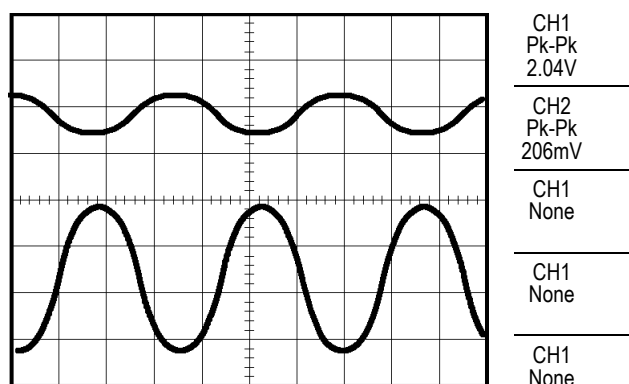
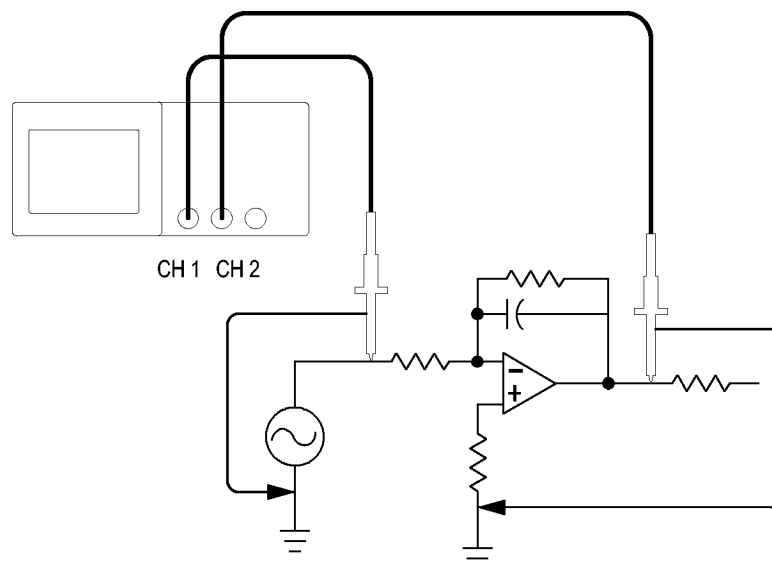

To activate and display the signals connected to channel 1 and to channel 2, and select measurements for the two channels, follow these steps:

1. Push the **AutoSet** button.
2. Push the **Measure** button to see the Measure Menu.
3. Push the top option button; the Measure 1 Menu appears.
4. Push **Source** ► **CH1**.
5. Push **Type** ► **Pk-Pk**.
6. Push the **Back** option button.

7. Push the second option button from the top; the Measure 2 Menu appears.
8. Push **Source** ► **CH2**.
9. Push **Type** ► **Pk-Pk**.
10. Push the **Back** option button.

Read the displayed peak-to-peak amplitudes for both channels.

11. To calculate the amplifier voltage gain, use these equations:

$$\text{VoltageGain} = \text{output amplitude}/\text{input amplitude}$$

$$\text{VoltageGain (dB)} = 20 \times \log_{10} (\text{VoltageGain})$$

## Using Autorange to Examine a Series of Test Points

If you have a machine that is malfunctioning, you may need to find the frequency and RMS voltage of several test points, and compare these values to ideal values. You are not able to access front-panel controls since you need to use both hands when probing test points that are difficult to physically reach.

1. Push the **1** (channel 1 menu) button.
2. Push **Probe ► Voltage ► Attenuation** and set to match the attenuation of the probe attached to channel 1.
3. Push the **AutoRange** button to activate autoranging, and select the **Vertical and Horizontal** option.
4. Push the **Measure** button to see the Measure Menu.
5. Push the top option button; the Measure 1 Menu appears.
6. Push **Source ► CH1**.
7. Push **Type ► Frequency**.
8. Push the **Back** option button.
9. Push the second option button from the top; the Measure 2 Menu appears.
10. Push **Source ► CH1**.
11. Push **Type ► Cyc RMS**.
12. Push the **Back** option button.
13. Attach the probe tip and reference lead to the first test point. Read the frequency and cycle RMS measurements from the oscilloscope display and compare these to the ideal values.
14. Repeat step 13 for each test point, until you find the malfunctioning component.

---

**NOTE.** *When Autorange is active, each time you move the probe to another test point, the oscilloscope readjusts the horizontal scale, the vertical scale, and the trigger level, to give you a useful display.*

---

## Taking Cursor Measurements

You can use the cursors to quickly take time and amplitude measurements on a waveform.

### Measuring Ring Frequency and Amplitude

To measure the ring frequency at the rising edge of a signal, follow these steps:

1. Push the **Cursor** button to see the Cursor Menu.
2. Push **Type ► Time**.
3. Push **Source ► CH1**.
4. Push the **Cursor 1** option button.
5. Turn the multipurpose knob to place a cursor on the first peak of the ring.
6. Push the **Cursor 2** option button.
7. Turn the multipurpose knob to place a cursor on the second peak of the ring.

You can see the  $\Delta$  (delta) time and frequency (the measured ring frequency) in the Cursor Menu.

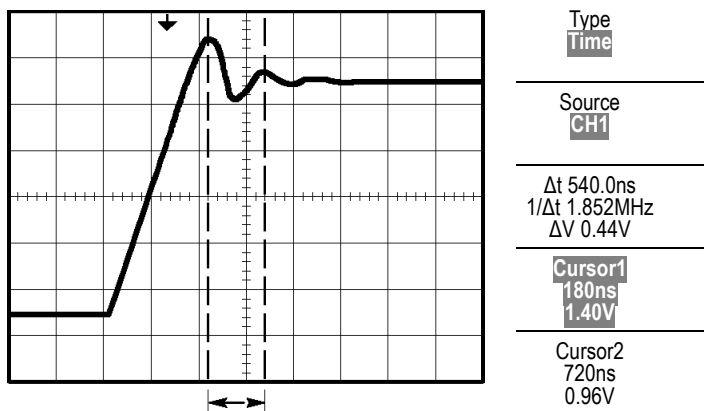

8. Push **Type ► Amplitude**.
9. Push the **Cursor 1** option button.
10. Turn the multipurpose knob to place a cursor on the first peak of the ring.
11. Push the **Cursor 2** option button.
12. Turn the multipurpose knob to place Cursor 2 on the lowest part of the ring.

You can see the amplitude of the ring in the Cursor Menu.

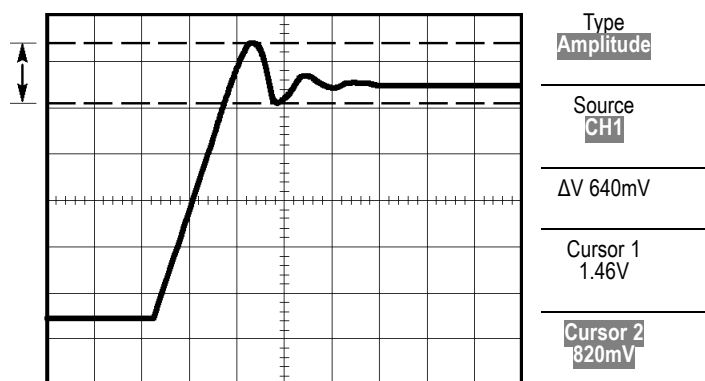

### Measuring Pulse Width

If you are analyzing a pulse waveform and you want to know the width of the pulse, follow these steps:

1. Push the **Cursor** button to see the Cursor Menu.
2. Push **Type** ► **Time**.
3. Push **Source** ► **CH1**.
4. Push the **Cursor 1** option button.
5. Turn the multipurpose knob to place a cursor on the rising edge of the pulse.
6. Push the **Cursor 2** option button.
7. Turn the multipurpose knob to place a cursor on the falling edge of the pulse.

You can see the following measurements in the Cursor Menu:

- The time at Cursor 1, relative to the trigger.
- The time at Cursor 2, relative to the trigger.
- The  $\Delta$  (delta) time, which is the pulse width measurement.

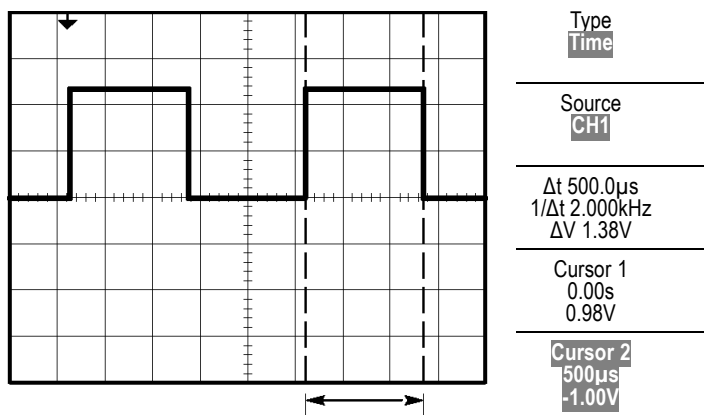

---

**NOTE.** The Positive Width measurement is available as an automatic measurement in the Measure Menu. (See page 89, Taking Measurements.)

---



---

**NOTE.** The Positive Width measurement also displays when you select the Single-Cycle Square option in the AutoSet Menu. (See page 81, Square Wave or Pulse.)

---

### Measuring Rise Time

After measuring the pulse width, you decide that you need to check the rise time of the pulse. Typically, you measure rise time between the 10% and 90% levels of the waveform. To measure the rise time, follow these steps:

1. Turn the **Horizontal Scale** (seconds/division) knob to display the rising edge of the waveform.
2. Turn the **Vertical Scale** (volts/division) and **Vertical Position** knobs to set the waveform amplitude to about five divisions.
3. Push the **1** (channel 1 menu) button.
4. Push **Volts/Div ► Fine**.
5. Turn the **Vertical Scale** (volts/division) knob to set the waveform amplitude to exactly five divisions.
6. Turn the **Vertical Position** knob to center the waveform; position the baseline of the waveform 2.5 divisions below the center graticule.
7. Push the **Cursor** button to see the Cursor Menu.
8. Push **Type ► Time**.
9. Push **Source ► CH1**.
10. Push the **Cursor 1** option button.

11. Turn the multipurpose knob to place a cursor at the point where the waveform crosses the second graticule line below center screen. This is the 10% level of the waveform.
12. Push the **Cursor 2** option button.
13. Turn the multipurpose knob to place a cursor at the point where the waveform crosses the second graticule line above center screen. This is the 90% level of the waveform.

The  $\Delta t$  readout in the Cursor Menu is the rise time of the waveform.

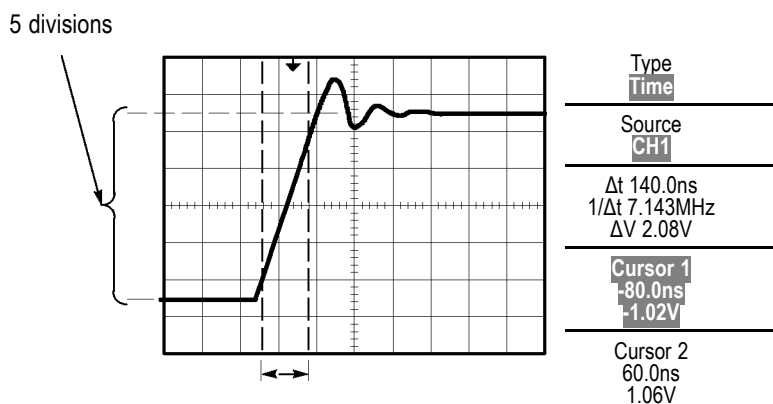

**NOTE.** The Rise Time measurement is available as an automatic measurement in the Measure Menu. (See page 89, Taking Measurements.)

**NOTE.** The Rise Time measurement also displays when you select the Rising Edge option in the AutoSet Menu. (See page 81, Square Wave or Pulse.)

## Analyzing Signal Detail

You have a noisy signal displayed on the oscilloscope and you need to know more about it. You suspect that the signal contains much more detail than you can now see in the display.

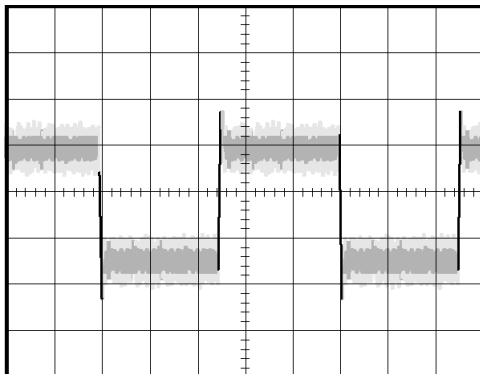

### Looking at a Noisy Signal

The signal appears noisy and you suspect that noise is causing problems in your circuit. To better analyze the noise, follow these steps:

1. Push the **Acquire** button to see the Acquire Menu.
2. Push the **Peak Detect** option button.

Peak detect emphasizes noise spikes and glitches in your signal, especially when the time base is set to a slow setting.

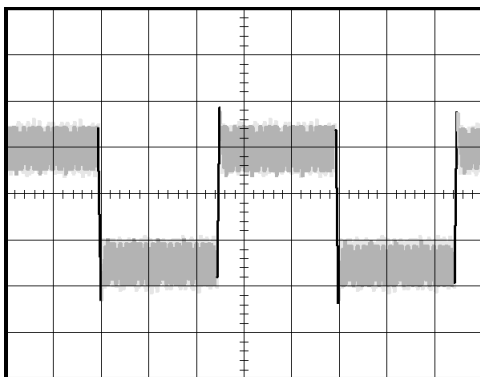

### Separating the Signal from Noise

Now you want to analyze the signal shape and ignore the noise. To reduce random noise in the oscilloscope display, follow these steps:

1. Push the **Acquire** button to see the Acquire Menu.
2. Push the **Average** option button.
3. Push the **Averages** option button to see the effects of varying the number of running averages on the waveform display.



Averaging reduces random noise and makes it easier to see detail in a signal. In the example below, a ring shows on the rising and falling edges of the signal when the noise is removed.

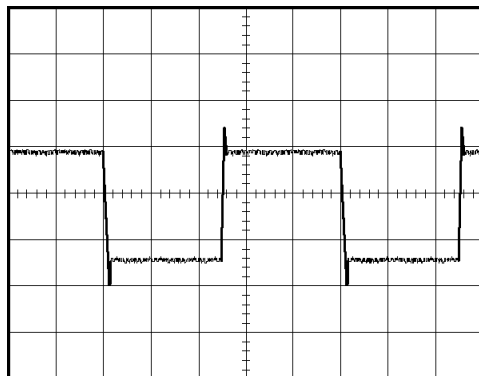

## Capturing a Single-Shot Signal

The reliability of a reed relay in a piece of equipment has been poor and you need to investigate the problem. You suspect that the relay contacts arc when the relay opens. The fastest that you can open and close the relay is about once per minute, so you need to capture the voltage across the relay as a single-shot acquisition.

To set up for a single-shot acquisition, follow these steps:

1. Turn the **Vertical Scale** (volts/division) and **Horizontal Scale** (seconds/division) knobs to the appropriate ranges for the signal you expect to see.
2. Push the **Acquire** button to see the Acquire Menu.
3. Push the **Peak Detect** option button.
4. Push the **Trig Menu** button to see the Trigger Menu.
5. Push **Slope ► Rising**.
6. Turn the **Level** knob to adjust the trigger level to a voltage midway between the open and closed voltages of the relay.
7. Push the **Single** button to start the acquisition.

When the relay opens, the oscilloscope triggers and captures the event.

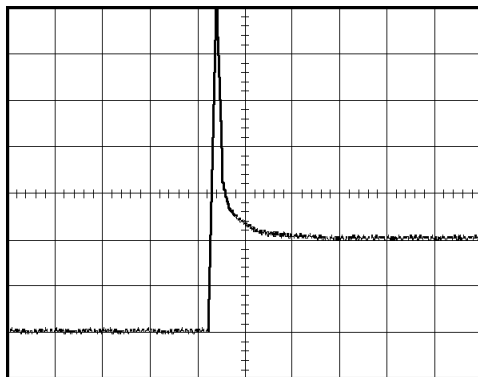

### Optimizing the Acquisition

The initial acquisition shows the relay contact beginning to open at the trigger point. This is followed by a large spike that indicates contact bounce and inductance in the circuit. The inductance can cause contact arcing and premature relay failure.

You can use the vertical, horizontal, and trigger controls to optimize the settings before the next single-shot event is captured. When the next acquisition is captured with the new settings (push the **Single** button again), you can see that the contact bounces several times as it opens.

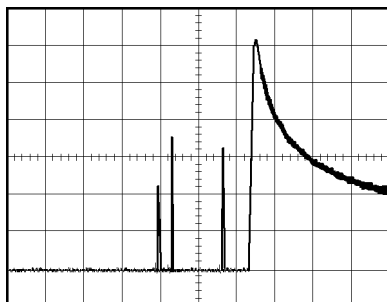

## Measuring Propagation Delay

You suspect that the memory timing in a microprocessor circuit is marginal. Set up the oscilloscope to measure the propagation delay between the chip-select signal and the data output of the memory device.

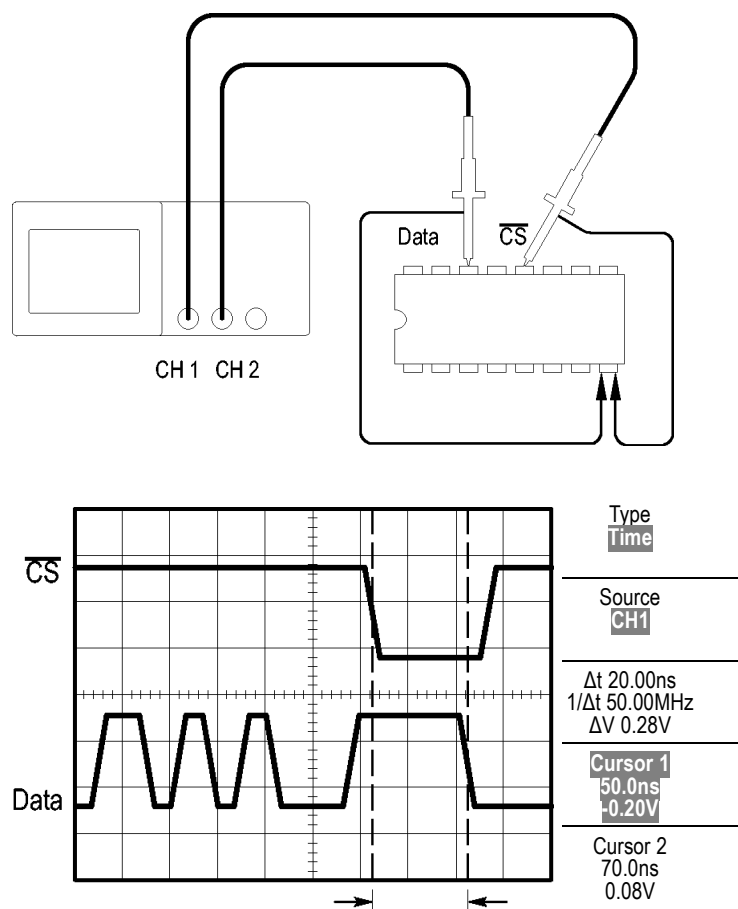

To set up to measure propagation delay, follow these steps:

1. Push the **AutoSet** button to trigger a stable display.
2. Adjust the horizontal and vertical controls to optimize the display.
3. Push the **Cursor** button to see the Cursor Menu.
4. Push **Type** ► **Time**.
5. Push **Source** ► **CH1**.
6. Push the **Cursor 1** option button.
7. Turn the multipurpose knob to place a cursor on the active edge of the chip-select signal.

8. Push the **Cursor 2** option button.
9. Turn the multipurpose knob to place the second cursor on the data output transition.

The  $\Delta t$  readout in the Cursor Menu is the propagation delay between the waveforms. The readout is valid because the two waveforms have the same horizontal scale (seconds/division) setting.

## Triggering on a Specific Pulse Width

You are testing the pulse widths of a signal in a circuit. It is critical that the pulses all be a specific width, and you need to verify that they are. Edge triggering shows that your signal is as specified, and the pulse width measurement does not vary from the specification. However, you think there might be a problem.

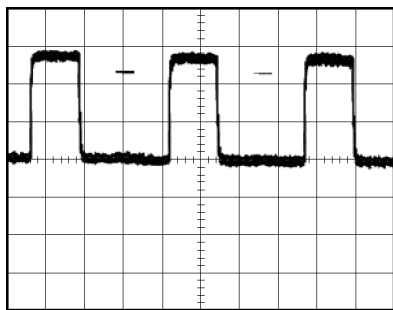

To set up a test for pulse width aberrations, follow these steps:

1. Push the **AutoSet** button to trigger a stable display.
2. Push the single cycle  option button in the AutoSet Menu to view a single cycle of the signal, and to quickly take a Pulse Width measurement.
3. Push the **Trig Menu** button to see the Trigger Menu.
4. Push **Type** ► **Pulse**.
5. Push **Source** ► **CH1**.
6. Turn the trigger **Level** knob to set the trigger level near the bottom of the signal.
7. Push **When** ► = (equals).
8. Turn the multipurpose knob to set the pulse width to the value reported by the Pulse Width measurement in step 2.
9. Push **More** ► **Mode** ► **Normal**.

You can achieve a stable display with the oscilloscope triggering on normal pulses.

1. Push the **When** option button to select  $\neq$ ,  $<$ , or  $>$ . If there are any aberrant pulses that meet the specified When condition, the oscilloscope triggers.

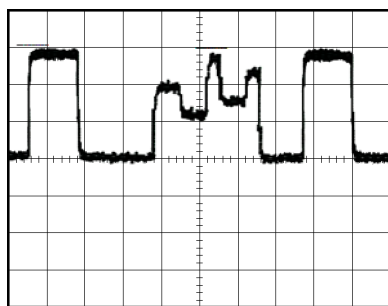

**NOTE.** The trigger frequency readout shows the frequency of events that the oscilloscope might consider to be a trigger, and may be less than the frequency of the input signal in Pulse Width trigger mode.

## Triggering on a Video Signal

You are testing the video circuit in a piece of medical equipment and need to display the video output signal. The video output is an NTSC standard signal. Use the video trigger to obtain a stable display.

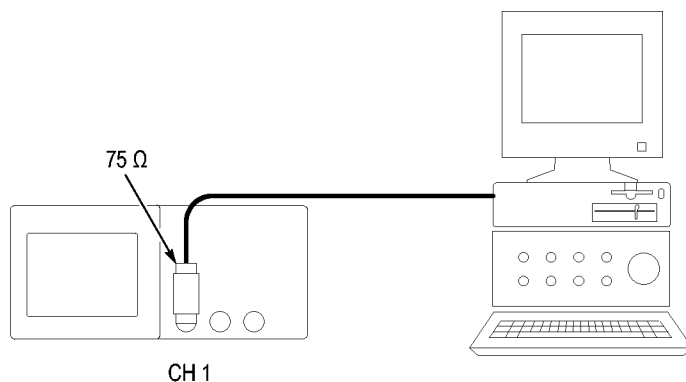

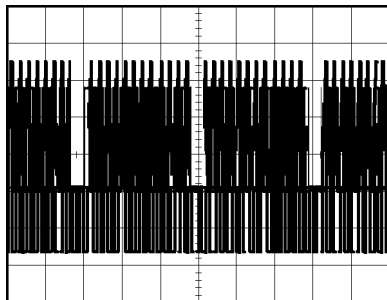

---

**NOTE.** Most video systems use 75 ohm cabling. The oscilloscope inputs do not properly terminate low impedance cabling. To avoid amplitude inaccuracy from improper loading and reflections, place a 75 ohm feedthrough terminator (Tektronix part number 011-0055-02 or equivalent) between the 75 ohm coaxial cable from the signal source and the oscilloscope BNC input.

---

### Triggering on Video Fields

**Automatic.** To trigger on the video fields, follow these steps:

1. Push the **AutoSet** button. When Autoset is complete, the oscilloscope displays the video signal with sync on **All Fields**.

The oscilloscope sets the Standard option when you use the Autoset function.

1. Push the **Odd Field** or **Even Field** option buttons from the **AutoSet** Menu to sync on odd or even fields only.

**Manual.** An alternative method requires more steps, but may be necessary depending on the video signal. To use the manual method, follow these steps:

1. Push the **1** (channel 1 menu) button.
2. Push **Coupling** ► **AC**.
3. Push the **Trig Menu** button to see the Trigger Menu.
4. Push the top option button and select **Video**.
5. Push **Source** ► **CH1**.
6. Push the **Sync** option button and select **All Fields**, **Odd Field**, or **Even Field**.
7. Push **Standard** ► **NTSC**.
8. Turn the **Horizontal Scale** (seconds/division) knob to see a complete field across the screen.
9. Turn the **Vertical Scale** (volts/division) knob to ensure that the entire video signal is visible on the screen.

## Triggering on Video Lines

**Automatic.** You can also look at the video lines in the field. To trigger on the video lines, follow these steps:

1. Push the **AutoSet** button.
2. Push the top option button to select **Line** to sync on all lines. (The AutoSet Menu includes **All Lines** and **Line Number** options.)

**Manual.** An alternative method requires more steps, but may be necessary depending on the video signal. To use this method, follow these steps:

1. Push the **Trig Menu** button to see the Trigger Menu.
2. Push the top option button and select **Video**.
3. Push the **Sync** option button and select **All Lines** or **Line Number** and turn the multipurpose knob to set a specific line number.
4. Push **Standard** ► **NTSC**.
5. Turn the **Horizontal Scale** (seconds/division) knob to see a complete video line across the screen.
6. Turn the **Vertical Scale** (volts/division) knob to ensure that the entire video signal is visible on the screen.

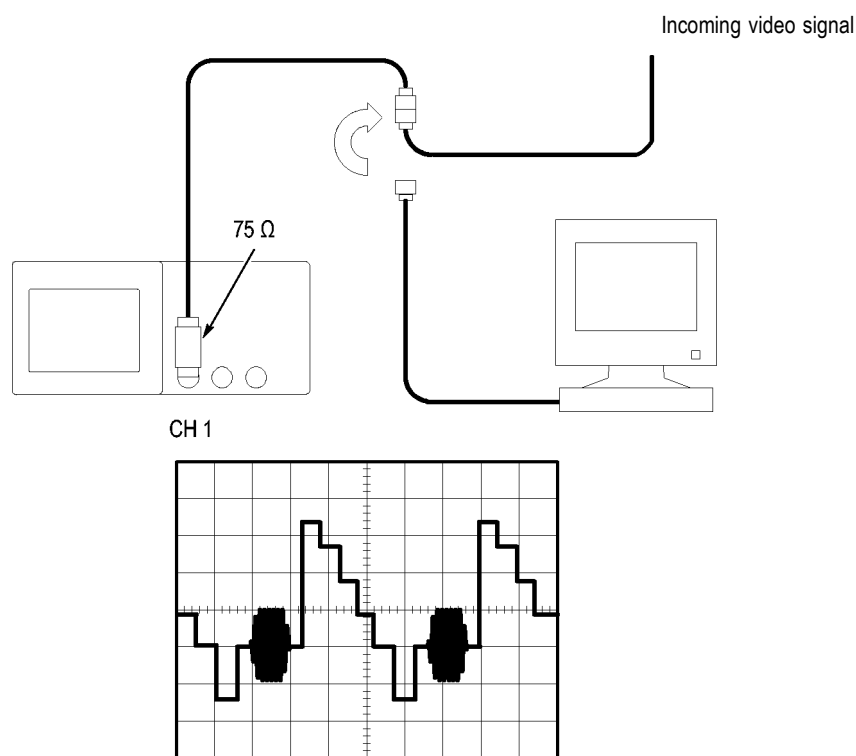

**Using the Window Function to See Waveform Details**

You can use the window (zoom) function to examine a specific portion of a waveform without changing the main display.

If you want to view the color burst in the previous waveform in more detail without changing the main display, follow these steps:

1. Push the **Horiz** button to see the Horizontal Menu and select the **Main** option.
2. Push the **Window Zone** option button.
3. Turn the horizontal **Scale** (seconds/division) knob and select 500 ns. This will be the seconds/division setting of the expanded view.
4. Turn the horizontal **Position** knob to position the window around the portion of the waveform that you want to expand.

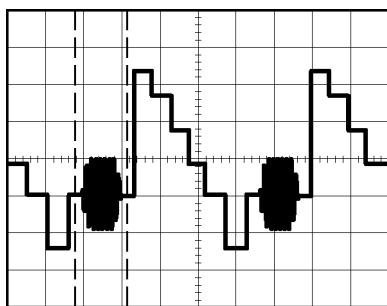

1. Push the **Window** option button to see the expanded portion of the waveform.
2. Turn the horizontal **Scale** (seconds/division) knob to optimize viewing the expanded waveform.

To switch between the Main and Window views, push the **Main** or **Window** option button in the Horizontal Menu.

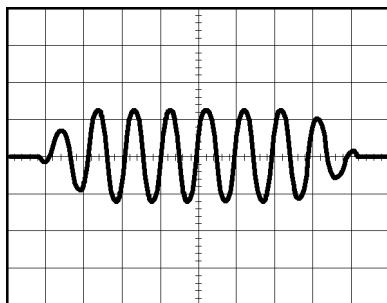



## Analyzing a Differential Communication Signal

You are having intermittent problems with a serial data communication link, and you suspect poor signal quality. Set up the oscilloscope to show you a snapshot of the serial data stream so you can verify the signal levels and transition times.

Because this is a differential signal, you use the Math function of the oscilloscope to view a better representation of the waveform.

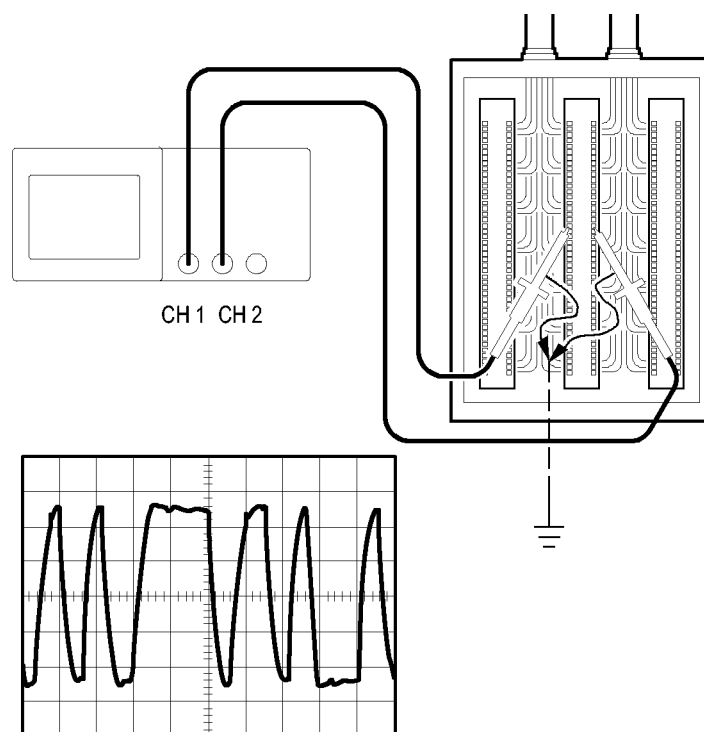

---

**NOTE.** Be sure to first compensate both probes. Differences in probe compensation appear as errors in the differential signal.

---

To activate the differential signals connected to channel 1 and to channel 2, follow these steps:

1. Push the **1** (channel 1 menu) button and set the **Probe ► Voltage ► Attenuation** option to **10X**.
2. Push the **2** (channel 2 menu) button and set the **Probe ► Voltage ► Attenuation** option to **10X**.
3. If using P2220 probes, set their switches to 10X.
4. Push the **AutoSet** button.
5. Push the **Math** button to see the Math Menu.

6. Push the **Operation** option button and select -.
7. Push the **CH1-CH2** option button to display a new waveform that is the difference between the displayed waveforms.
8. To adjust the vertical scale and position of the Math waveform, follow these steps:
  - a. Remove the channel 1 and channel 2 waveforms from the display.
  - b. Turn the channel 1 and channel 2 **Vertical Scale** and **Vertical Position** knobs to adjust the vertical scale and position of the Math waveform.

For a more stable display, push the **Single** button to control the acquisition of the waveform. Each time you push the **Single** button, the oscilloscope acquires a snapshot of the digital data stream. You can use the cursors or automatic measurements to analyze the waveform, or you can store the waveform to analyze later.

## Viewing Impedance Changes in a Network

You have designed a circuit that needs to operate over a wide temperature range. You need to evaluate the change in impedance of the circuit as the ambient temperature is changed.

Connect the oscilloscope to monitor the input and output of the circuit and capture the changes that occur as you vary the temperature.

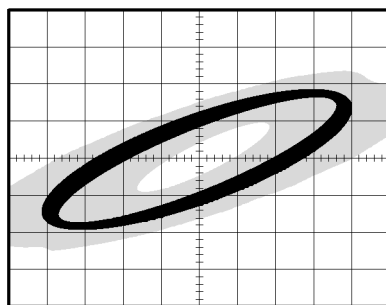
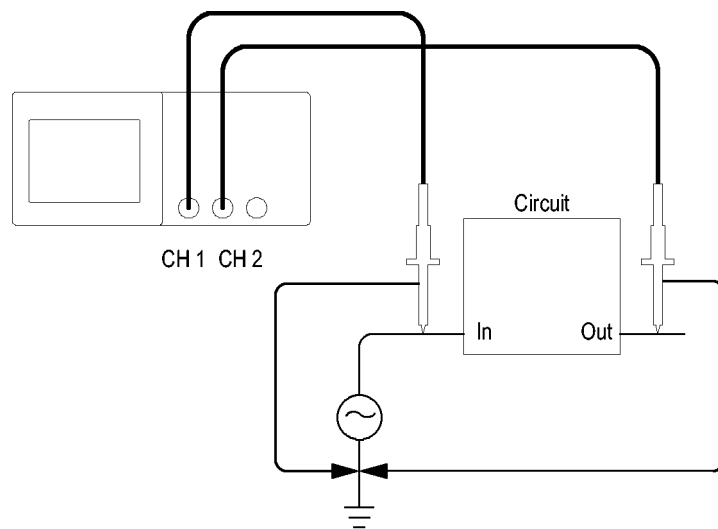

To view the input and output of the circuit in an XY display, follow these steps:

1. Push the **1** (channel 1 menu) button.
2. Push **Probe** ► **Voltage** ► **Attenuation** ► **10X**.
3. Push the **2** (channel 2 menu) button.
4. Push **Probe** ► **Voltage** ► **Attenuation** ► **10X**.
5. If using P2220 probes, set their switches to **10X**.
6. Connect the channel 1 probe to the input of the network, and connect the channel 2 probe to the output.
7. Push the **AutoSet** button.
8. Turn the **Vertical Scale** (volts/division) knobs to display approximately the same amplitude signals on each channel.
9. Push the **Display** button to see the Display Menu.
10. Push **Format** ► **XY**.

The oscilloscope displays a Lissajous pattern representing the input and output characteristics of the circuit.

11. Turn the vertical **Scale** and vertical **Position** knobs to optimize the display.
12. Push **Persist ► Infinite**.

As you adjust the ambient temperature, the display persistence captures the changes in the characteristics of the circuit.

## Data Logging (not available on TDS1000C-EDU models)

You want to use the oscilloscope to record data from a source over time. You can configure the trigger conditions and direct the oscilloscope to save all the triggered waveform together with timing information over a defined time duration to a USB memory device.

1. Configure the oscilloscope to use the desired trigger conditions to collect the data. Also, insert a USB memory device in the front-panel USB port.
2. Push the front-panel **Utility** button.
3. Select **Data Logging** from the resulting side menu to bring up the data logging menu.
4. Push **Data Logging** from the side menu to select **On**. This enables the data logging feature. When the feature is enabled but not yet triggering, the oscilloscope will display a “Data Logging – Waiting for trigger” message.

Before turning on the data logging feature, you must first select the source, the time duration, and the folder.

5. Push the **Source** button to select the signal source to log data from. You can use either one of the input channels or the Math waveform.
6. Push the **Duration** button as many times as needed or use the multipurpose knob to select the duration for data logging. The selections range from 0.5 hour to 8 hours in 30 minute increments and from 8 hours to 24 hours in 60 minute increments. You can select **Infinite** to run data logging with no set time limit.
7. Push the **Select Folder** button to define where to store the collected information. The resulting menu choices will let you either select an existing folder or define a new folder. When done, push **Back** to return to the main data logging menu
8. Start the data acquisition, such as by pushing either the front-panel **Single** or **Run/Stop** button.
9. When the oscilloscope finishes the requested data logging operation, it displays a “Data logging completed” message and turns off the data logging feature.

## Limit Testing (not available on TDS1000C-EDU models)

You want to use the oscilloscope to monitor an active input signal against a template and to output pass or fail results by judging whether the input signal is within the bounds of the template.

1. Push the front-panel **Utility** button.
2. Select **Limit Test** from the resulting side menu to bring up the limit testing menu.
3. Select **Source** from the side menu to define the source of the waveform to compare against the limit test template.
4. Select **Compare To** to specify the limit test template against which to compare test signals sectioned with the **Source** menu item.
5. Push **Template Setup** from the side menu to define the boundary to compare with the input source signals. You can create the template from internal or external waveforms with specific horizontal and vertical tolerances. You can also create them from previously saved template settings.

On the resulting side menu,

Push **Source** to set the location of the signal source used to create the limit test template.

Push **V Limit** and turn the multipurpose knob to set the vertical limitation value, in vertical divisions, by which you can vary the source waveform vertically when you create the test template.

Push **H Limit** and turn the multipurpose knob to set the horizontal limitation value, in horizontal divisions, by which you can vary the source waveform horizontally when you create the test template.

Push **Apply Template** to store the template waveform to the reference channel selected in the **Destination** menu.

Push **Destination** to set the location of the reference memory location used to store the limit test template.

Push **Display Template** and toggle between **On** and **Off** to display or not a stored template.

6. Push the **Action on Violation** button and select an action from the resulting menu to describe what the oscilloscope will do after it detects a violation. You can select between **Save Waveform** and **Save Image**.
7. Push the **Stop After** button and toggle the resulting button with the same name to define the conditions that will stop limit testing. Select **Waveforms**, **Violations**, or **Time** and use the multipurpose knob to set the desired number

of waveforms, number of violations, or the time in seconds at which to stop. You can also choose to stop the testing manually.

8. Push the **Run/Stop Test** button to toggle between starting and ending the limit test. After you end the test, the oscilloscope will display the test statistics on the screen. This includes the number of cases tested, the number of cases passed, and the number of cases failed.

---

# Math FFT

This chapter contains detailed information on how to use the Math FFT (Fast Fourier Transform). You can use the FFT Math mode to convert a time-domain (YT) signal into its frequency components (spectrum). You can use the Math FFT mode for the following types of analysis:

- Analyze harmonics in power lines
- Measure harmonic content and distortion in systems
- Characterize noise in DC power supplies
- Test impulse response of filters and systems
- Analyze vibration

To use the Math FFT mode, you need to perform the following tasks:

- Set up the source (time-domain) waveform
- Display the FFT spectrum
- Select a type of FFT window
- Adjust the sample rate to display the fundamental frequency and harmonics without aliasing
- Use zoom controls to magnify the spectrum
- Use cursors to measure the spectrum

## Setting Up the Time-Domain Waveform

Before you use FFT mode, you need to set up the time-domain (YT) waveform. To do so, follow these steps:

1. Push **AutoSet** to display a YT waveform.
2. Turn the vertical **Position** knob to move the YT waveform to the center vertically (zero divisions).

This ensures that the FFT will show a true DC value.

3. Turn the **Horizontal Position** knob to position the part of the YT waveform that you want to analyze in the center eight divisions of the screen.

The oscilloscope calculates the FFT spectrum using the center 2048 points of the time-domain waveform.

4. Turn the **Vertical Scale** (volts/division) knob to ensure that the entire waveform remains on the screen. The oscilloscope may display erroneous FFT results (by adding high frequency components) if the entire waveform is not visible.
5. Turn the **Horizontal Scale** (seconds/division) knob to provide the resolution you want in the FFT spectrum.
6. If possible, set the oscilloscope to display many signal cycles.

If you turn the horizontal **Scale** knob to select a faster setting (fewer cycles), the FFT spectrum shows a larger frequency range, and reduces the possibility of FFT aliasing. (See page 59, *FFT Aliasing*.) However, the oscilloscope also displays less frequency resolution.

To set up the FFT display, follow these steps:

1. Push the **Math** button to see the Math Menu.
2. Push **Operation ► FFT**.
3. Select the **Math FFT Source** channel.

In many cases, the oscilloscope can produce a useful FFT spectrum even if the YT waveform is not triggered. This is especially true if your signal is periodic or random (noisy).

---

**NOTE.** *Trigger and position any transient or burst waveforms as closely as possible to the center of the screen.*

---

## Nyquist Frequency

The highest frequency that any real-time digitizing oscilloscope can measure without errors is one-half the sample rate. This frequency is called the Nyquist frequency. Frequency information above the Nyquist frequency is undersampled, which causes FFT aliasing. (See page 59, *FFT Aliasing*.)

The math function transforms the center 2048 points of the time-domain waveform into an FFT spectrum. The resulting FFT spectrum contains 1024 points that go from DC (0 Hz) to the Nyquist frequency.

Normally, the display compresses the FFT spectrum horizontally into 250 points, but you can use the FFT Zoom function to expand the FFT spectrum to more clearly see the frequency components at each of the 1024 data points in the FFT spectrum.

---

**NOTE.** *The oscilloscope vertical response rolls off slowly above its bandwidth (40 MHz, 60 MHz, 100 MHz or 200 MHz, depending on the model, or 20 MHz when the Bandwidth Limit option is ON). Therefore, the FFT spectrum can show valid frequency information higher than the oscilloscope bandwidth. However, the magnitude information near or above the bandwidth will not be accurate.*

---



## Displaying the FFT Spectrum

Push the **Math** button to display the Math Menu. Use the options to select the Source channel, Window algorithm, and FFT Zoom factor. You can display only one FFT spectrum at a time.

Math FFT option	Settings	Comments
Source	CH1, CH2, CH3 <sup>1</sup> , CH4 <sup>1</sup>	Selects the channel used as the FFT source
Window	Hanning, Flattop, Rectangular	Selects the FFT window type; (See page 58, <i>Selecting an FFT Window.</i> )
FFT Zoom	X1, X2, X5, X10	Changes the horizontal magnification of the FFT display; (See page 61, <i>Magnifying and Positioning an FFT Spectrum.</i> )

<sup>1</sup> Available only on a 4-channel oscilloscope.

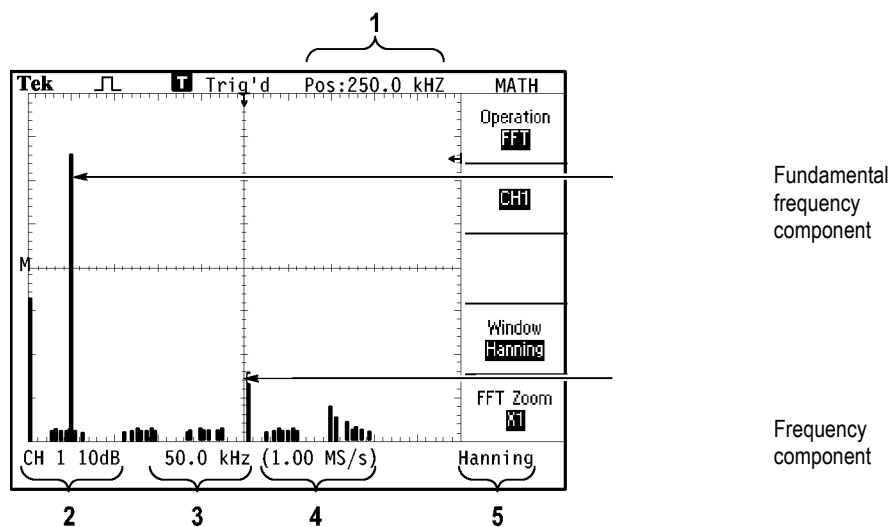

1. Frequency at the center graticule line.
2. Vertical scale in dB per division (0 dB = 1 V<sub>RMS</sub>).
3. Horizontal scale in frequency per division.
4. Sample rate in number of samples per second.
5. FFT window type.

## Selecting an FFT Window

Windows reduce spectral leakage in the FFT spectrum. The FFT assumes that the YT waveform repeats forever. With an integral number of cycles (1, 2, 3, ...), the YT waveform starts and ends at the same amplitude and there are no discontinuities in the signal shape.

A non-integral number of cycles in the YT waveform causes the signal start and end points to be at different amplitudes. The transitions between the start and end points cause discontinuities in the signal that introduce high-frequency transients.

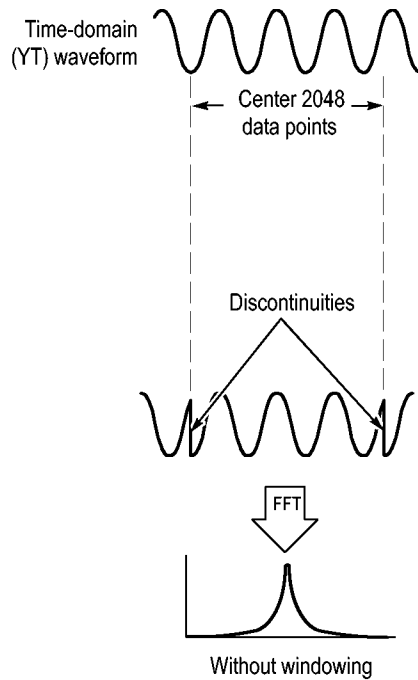

Applying a window to the YT waveform changes the waveform so that the start and stop values are close to each other, reducing the discontinuities.

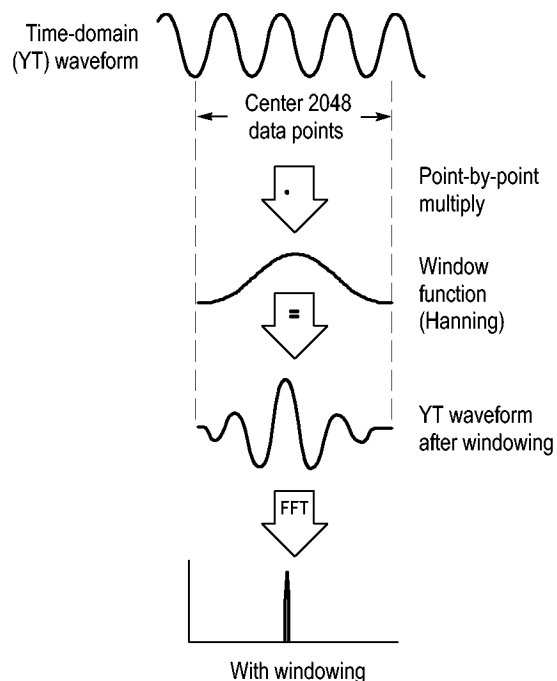

The Math FFT function includes three FFT Window options. There is a trade-off between frequency resolution and amplitude accuracy with each type of window. What you want to measure and your source signal characteristics will help you to determine which window to use.

Window	Measure	Characteristics
Hanning	Periodic waveforms	Better frequency, poorer magnitude accuracy than Flattop
Flattop	Periodic waveforms	Better magnitude, poorer frequency accuracy than Hanning
Rectangular	Pulses or transients	Special-purpose window for waveforms that do not have discontinuities. This is essentially the same as no window

### FFT Aliasing

Problems occur when the oscilloscope acquires a time-domain waveform containing frequency components that are greater than the Nyquist frequency. (See page 56, *Nyquist Frequency*.) The frequency components that are above the Nyquist frequency are undersampled, appearing as lower frequency components that "fold back" around the Nyquist frequency. These incorrect components are called aliases.

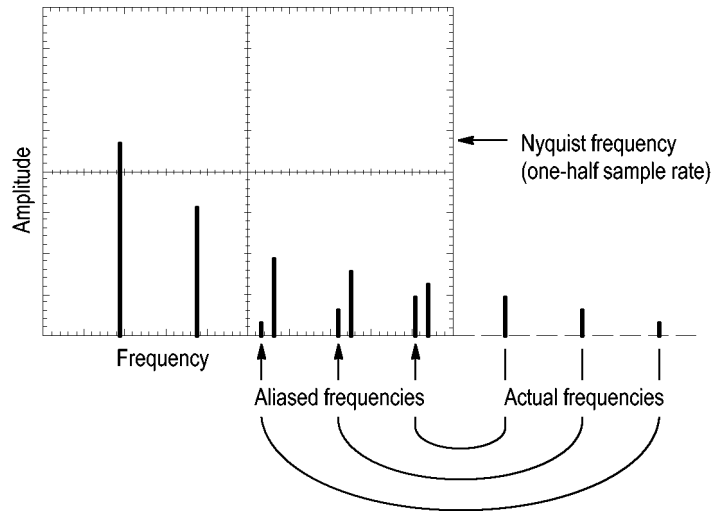

## Eliminating Aliases

To eliminate aliases, try the following remedies:

- Turn the **Horizontal Scale** (seconds/division) knob to set the sample rate to a faster setting. Since you increase the Nyquist frequency as you increase the sample rate, the aliased frequency components appear at their proper frequency. If too many frequency components are shown on the screen, you can use the FFT Zoom option to magnify the FFT spectrum.
- If you do not need to view frequency components above 20 MHz, set the Bandwidth Limit option to On.
- Put an external filter on the source signal to bandwidth limit the source waveform to frequencies below that of the Nyquist frequency.
- Recognize and ignore the aliased frequencies.
- Use zoom controls and the cursors to magnify and measure the FFT spectrum.

## Magnifying and Positioning an FFT Spectrum

You can magnify and use cursors to take measurements on the FFT spectrum. The oscilloscope includes an FFT Zoom option to magnify horizontally. To magnify vertically, you can use the vertical controls.

### Horizontal Zoom and Position

The FFT Zoom option lets you horizontally magnify the FFT spectrum without changing the sample rate. Zoom factors are X1 (default), X2, X5, and X10. At zoom factor X1, and with the waveform centered in the graticule, the left graticule line is at 0 Hz and the right graticule line is at the Nyquist frequency.

When you change the zoom factor, the FFT spectrum is magnified about the center graticule line. In other words, the axis of horizontal magnification is the center graticule line.

Turn the **Horizontal Position** knob clockwise to move the FFT spectrum to the right. Push the **Set To Zero** button to position the center of the spectrum at the center of the graticule.

### Vertical Zoom and Position

The channel vertical knobs become vertical zoom and position controls for their respective channels when displaying the FFT spectrum. The **Vertical Scale** knob provides zoom factors of X0.5, X1 (default), X2, X5, and X10. The FFT spectrum is vertically magnified about the M marker (math waveform reference point on the left edge of the screen).

Turn the **Vertical Position** knob clockwise to move the spectrum up for the source channel.

## Measuring an FFT Spectrum Using Cursors

You can take two measurements on FFT spectrums: magnitude (in dB), and frequency (in Hz). Magnitude is referenced to 0 dB, where 0 dB equals  $1 V_{\text{RMS}}$ .

You can use the cursors to take measurements at any zoom factor. To do so, follow these steps:

1. Push the **Cursor** button to see the Cursor Menu.
2. Push **Source** ► **MATH**.
3. Push the **Type** option button to select **Magnitude** or **Frequency**.
4. Use the multipurpose knob to move cursors 1 and 2.

Use horizontal cursors to measure magnitude and vertical cursors to measure frequency. The options display the delta between the two cursors, the value at cursor 1 position, and the value at cursor 2 position. Delta is the absolute value of cursor 1 minus cursor 2.

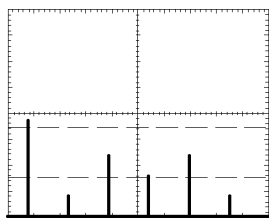

Magnitude cursors

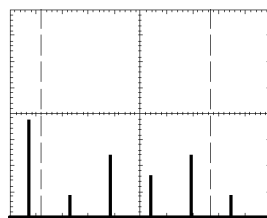

Frequency cursors

You can also take a frequency measurement without using the cursors. To do so, turn the Horizontal Position knob to position a frequency component on the center graticule line and read the frequency at the top right of the display.

# USB Flash Drive and Device Ports

This chapter describes how to use the Universal Serial Bus (USB) ports on the oscilloscope to do the following tasks:

- Save and recall waveform data or setup data, or save a screen image
- Print a screen image
- Transfer waveform data, setup data, or a screen image to a PC
- Control the oscilloscope with remote commands

To use the PC Communications software, launch and refer to the online help from the software.

## USB Flash Drive Port

The front of the oscilloscope has a USB Flash Drive port to accommodate a USB flash drive for file storage. The oscilloscope can save data to and retrieve data from the flash drive.



---

**NOTE.** *The oscilloscope can only support flash drives with a storage capacity of 64 GB or less.*

---

To connect a USB flash drive, follow these steps:

1. Align the USB flash drive with the USB Flash Drive port on the oscilloscope. Flash drives are shaped for proper installation.
2. Insert the flash drive into the port until the drive is fully inserted.

For flash drives with an LED, the drive "blinks" while the oscilloscope writes data to or reads data from the drive. The oscilloscope also displays a clock symbol to indicate when the flash drive is active.

After a file is saved or retrieved, the LED on the drive (if any) stops blinking, and the oscilloscope removes the clock. A hint line also displays to notify you that the save or recall operation is complete.

To remove a USB flash drive, wait until the LED on the drive (if any) stops blinking or until the hint line appears that says the operation is complete, grab the edge of the drive, and extract the drive from the port.

### Flash Drive Initial Read Time

The oscilloscope reads the internal structure of a USB flash drive each time you install a drive. The time to complete the read depends on the size of the flash drive, how the drive is formatted, and the number of files stored on the drive.

---

**NOTE.** *To significantly shorten the initial read time of 64 MB and larger USB flash drives, format the drive on your PC.*

---

### Formatting a Flash Drive

The Format function deletes all data on the USB flash drive. To format a flash drive, follow these steps:

1. Insert a USB flash drive into the Flash Drive port on the front of the oscilloscope.
2. Push the **Utility** button to see the Utility Menu.
3. Push **File Utilities ► More ► Format**.
4. Select **Yes** to format the flash drive.

### Flash Drive Capacities

The oscilloscope can store the following types and number of files per 1 MB of USB flash drive memory:

- 5 Save All operations; (See page 67, *Saves All to Files.*) (See page 92, *Save All.*)
- 16 screen image files (capacity depends on the image format); (See page 68, *Saves Image to File.*) (See page 92, *Save Image.*)
- 250 oscilloscope setting (.SET) files; (See page 93, *Save Setup.*)
- 18 waveform (.CSV) files; (See page 94, *Save Waveform.*)

## File Management Conventions

The oscilloscope uses the following file management conventions for data storage:

- The oscilloscope checks for available space on the USB flash drive before writing files, and displays a warning message if there is not enough memory available.
- The term “folder” refers to a directory location on the USB flash drive.
- The default location for the file save or file recall functions is the current folder.



- A:\ is the root folder.
- The oscilloscope resets the current folder to A:\ when you power on the oscilloscope, or when you insert a USB flash drive after the oscilloscope is powered on.
- File names can have one to eight characters, followed by a period, and then followed with an extension of one to three characters.
- The oscilloscope displays long file names created on PC operating systems with the shortened file name from the operating system.
- File names are case insensitive and are displayed in upper case.

You can use the File Utilities menu to do the following tasks:

- List the contents of the current folder
- Select a file or folder
- Navigate to other folders
- Create, rename, and delete files and folders
- Format the USB flash drive

(See page 103, *File Utilities for the USB Flash Drive*.)

## Saving and Recalling Files With a USB Flash Drive

There are two ways to operate the USB flash drive for file storage:

- through the Save/Recall menu
- through the alternative Save function of the Print button

You can use the following Save/Recall menu options to write data to or retrieve data from a USB flash drive:

- Save Image
- Save Setup
- Save Waveform
- Recall Setup
- Recall Waveform

---

**NOTE.** The  print button can be used as a save button for quick storage of files to a flash drive. For information on how to save many files at once, or images one after another, refer to *Using the Save Functions of the Print Button*. (See page 67, *Using the Save Function of the Print Front Panel Button*.)

---

**Save Image, Save Setup, and Save Waveform Options**

You can save a screen image, the oscilloscope settings, or waveform data to a file on the USB flash drive through the Save/Recall menu.

Each save option operates in a similar way. As an example, to save a screen image file to a flash drive, follow these steps:

1. Insert a USB flash drive into the USB Flash Drive port.
2. Push **Utility ► Options ► Printer Setup** and set the following options:

Ink Saver	On, Off	Prints the screen image on a white background when you select On
Layout	Portrait, Landscape	Printer output orientation

3. Access the screen you want to save.
4. Push the **Save/Recall** front panel button.
5. Select the **Action ► Save Image ► Save** option.

The oscilloscope saves the screen image in the current folder and automatically generates the file name. (See page 91, *Save/Recall*.)

**Recall Setup, and Recall Waveform Options**

You can recall the oscilloscope settings or waveform data from a file on the USB flash drive through the Save/Recall menu.

Each recall option operates in a similar way. As an example, to recall a waveform file from a USB flash drive, follow these steps:

1. Insert the USB flash drive that contains the desired waveform file into the USB Flash Drive port on the front of the oscilloscope.
2. Push the **Save/Recall** front panel button.
3. Select the **Action ► Recall Waveform ► Select File** option.

You can use the Change Folder option to navigate to another folder on the flash drive.

4. Turn the multipurpose knob to select the waveform file to recall.

The name of the file in the Recall option changes as you scroll.

5. Select the **To** option and specify which reference memory location to recall the waveform to RefA or RefB. RefC and RefD are available on 4-channel models.
6. Push the **Recall FnnnnCHx.CSV** option button, where FnnnnCHx.CSV is the name of the waveform file.

---

**NOTE.** For folders on the flash drive that contain one waveform file, select the **Save/Recall ► Action ► Recall Waveform ► To** option and specify the reference memory location to recall the waveform to. The name of the file appears in the **Recall** option. (See page 91, Save/Recall.)

---

## Using the Save Function of the Print Front Panel Button

You can set the  (print) front panel button to write data to the USB flash drive as an alternative function. To set the function of the button to save data, access one of the following options:

- **Save/Recall ► Save All ► PRINT Button**
- **Utility ► Options ► Printer Setup**

---

**NOTE.** An LED by the print button lights to indicate the alternative Save function that writes data to the USB flash drive.

---

### Saves All to Files

The Saves All to Files option lets you save the current oscilloscope information to files on the USB flash drive. A single Saves All to Files action uses less than 700 kB of space on the flash drive.

Before you can save data to the USB flash drive, you need to change the  print front panel button to the alternative Save function. To do so, select the **Save/Recall ► Save All ► PRINT Button ► Saves All to Files** option.

To save all the oscilloscope files to a USB flash drive, follow these steps:

1. Insert a USB flash drive into the USB Flash Drive port.
2. To change the folder designated as the current folder, push the **Select Folder** option button.

The oscilloscope creates a new folder within the current folder each time you push the PRINT front panel button, and automatically generates the folder name.

3. Set up the oscilloscope to capture your data.
4. Push the  print (Save) button.

The oscilloscope creates a new folder on the flash drive and saves the screen image, waveform data, and setup data in separate files in that new folder, using the current oscilloscope and file format settings. The oscilloscope names the folder ALLnnnn. (See page 91, *Save/Recall*.)

To see a list of the files created by the Saves All To Files function, access the **Utility ► File Utilities** menu.

Source	File name
CH(x)	FnnnnCHx.CSV, where nnnn is an automatically-generated number, and x is the channel number
MATH	FnnnnMTH.CSV
Ref(x)	FnnnnRFx.CSV, where x is the reference memory letter
Screen Image	FnnnnTEK.???, where ??? is the current file format
Settings	FnnnnTEK.SET

File type	Contents and uses
.CSV	Contains ASCII text strings that list the time (relative to the trigger) and amplitude values for each of the 2500 waveform data points; you can import .CSV files into many spreadsheet and math analysis applications.
.SET	Contains an ASCII text string listing of the oscilloscope settings; refer to the <i>TDS2000C and TPS2000 Series Digital Oscilloscopes Programmer Manual</i> to decode strings.
Screen images	Import files into spreadsheet and word processing applications; type of image file depends on the application.

**NOTE.** *The oscilloscope stores these settings until you change them, even if you push the **Default Setup** button.*

### Saves Image to File

This option lets you save the oscilloscope screen image to a file named TEKnnnn.???, where the .??? is the current Saves Image to File format. The next table lists the file formats.

File format	Extension	Comments
BMP	BMP	This bitmap format uses a lossless algorithm, and is compatible with most word processing and spreadsheet programs; this is the default.
EPSIMAGE	EPS	Postscript format
JPEG	JPG	This bitmap format uses a lossy compression algorithm, and is commonly used by digital cameras and by other digital photographic applications.
PCX	PCX	DOS Paintbrush format

File format	Extension	Comments
RLE	RLE	Run-length encoding; this format uses a lossless compression algorithm.
TIFF	TIF	Tagged Image File Format

Before you can save data to the USB flash drive, you must change the print button to the alternative Save function. To do so, select the **Save/Recall ► Save All ► PRINT Button ► Saves Image to File** option. The Save LED adjacent to the  print button lights to indicate the alternative function.

To save a screen image to a USB flash drive, follow these steps:

1. Insert a USB flash drive into the USB Flash Drive port.
2. To change the folder designated as the current folder, push the **Select Folder** option button.
3. Access the screen you want to save.
4. Push the  print (Save) button.

The oscilloscope saves the screen image and automatically generates the file name.

To see a list of the files created by the Save Image To File function, you can access the **Utility ► File Utilities** menu.

## USB Device Port

You can use a USB cable to connect the oscilloscope to a PC, or to a PictBridge compatible printer. The USB Device port is on the rear of the oscilloscope.

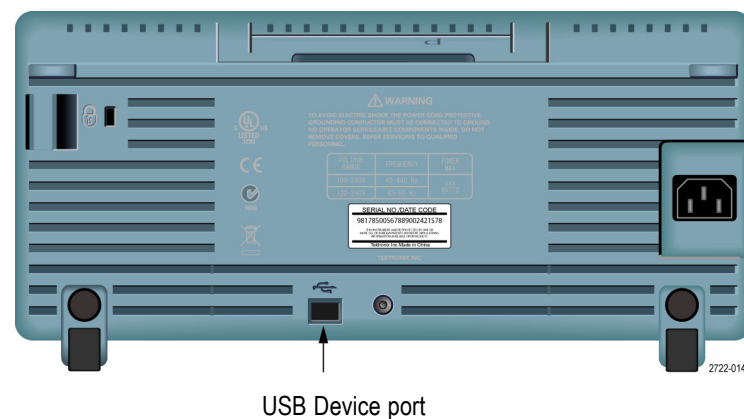

## Installing the PC Communications Software on a PC

Before you connect the oscilloscope to a PC, you must install the PC Communications software from the CD that came with the oscilloscope.



---

**CAUTION.** *If you connect the oscilloscope to your PC before you install the software, the PC will not recognize the oscilloscope. The PC will label the oscilloscope as an Unknown Device and not communicate with the oscilloscope. To avoid this, install the software on your PC before you connect the oscilloscope to your PC.*

---

---

**NOTE.** *Be sure you have installed the same version of PC Communications software that came with the oscilloscope or a later version.*

*Software for your oscilloscope is also available through the Software finder on the Tektronix web site.*

---

To install the PC Communications software, follow these steps:

1. Insert the CD-ROM that came with your oscilloscope into the CD drive on the PC. The InstallShield wizard appears on the screen.
2. Follow the on-screen directions.
3. Exit the InstallShield wizard.

## Connecting to a PC

After you install the software on your PC, you can connect the oscilloscope to the PC.

---

**NOTE.** *You must install the software before you connect the oscilloscope to the PC. (See page 70, *Installing the PC Communications Software on a PC.*)*

---

To connect the oscilloscope to the PC, follow these steps:

1. Power on the oscilloscope.
2. Insert one end of a USB cable into the USB Device port on the back of the oscilloscope.
3. Power on the PC.
4. Insert the other end of the cable into the desired USB port on a PC.
5. If a Found New Hardware message appears, follow the on-screen directions for the Found New Hardware wizard.

Do NOT search for the hardware to install on the web.

6. For a Windows XP systems, follow these steps:
  - a. If you see the Tektronix PictBridge Device dialog box, click Cancel.
  - b. When prompted, select the option that tells Windows NOT to connect to Windows Update, and click Next.
  - c. In the next window, you should see that you are installing software for a USB Test and Measurement Device. If you do not see USB Test and Measurement Device software, the software that came with your oscilloscope is not properly installed.
  - d. Select the option that installs the software automatically (the recommended option) and click Next.

Windows will install the driver for your oscilloscope.

- e. If you do not see the USB Test and Measurement Device in step c, or if Windows cannot find the software driver, the software that came with your oscilloscope is not properly installed.

In these situations, click Cancel to exit the Found New Hardware wizard. Do NOT allow the wizard to finish.

Unplug the USB cable from your oscilloscope and install the software from the CD that came with your oscilloscope.

Reconnect your oscilloscope to the PC and follow steps 6a, 6b, 6c, and 6d.

- f. Click Finish.
- g. If a dialog labeled Test and Measurement Device appears, select what you would like Windows to do, and click OK.

7. For Windows 2000 systems:

- a. When prompted, select the option that tells Windows to display a list of known drivers and click Next.
- b. In the next window, select USB Test and Measurement Device. If you do not see a USB Test and Measurement Device selection, the software that came with your oscilloscope is not properly installed.
- c. In the next window, click Next to allow Windows to install the driver for your oscilloscope.

Windows will install the driver for your oscilloscope.

- d. If you do not see the USB Test and Measurement Device in step b, or if Windows cannot find the software driver, the software that came with your oscilloscope is not properly installed.

In these situations, click Cancel to exit the Found New Hardware wizard. Do NOT allow the wizard to finish.

Unplug the USB cable from your oscilloscope, and install the software from the CD that came with your oscilloscope.

Reconnect your oscilloscope to the PC and follow steps 7a, 7b, and 7c.

8. When prompted, click Finish.
9. If Windows asks you to insert a CD, click Cancel.
10. Run the PC Communications software on your PC.
11. If the oscilloscope and PC do not communicate, refer to the PC Communications online help and documentation.

## Connecting to a GPIB System

If you want to communicate between the oscilloscope and a GPIB system, use a TEK-USB-488 adapter and follow these steps:

1. Connect the oscilloscope to a TEK-USB-488 adapter with a USB cable.  
  
The Accessories appendix has information on how to order an adapter. (See page 123, *Accessories*.)
2. Connect the TEK-USB-488 adapter to your GPIB system with a GPIB cable.
3. Push the **Utility ► Option ► GPIB Setup ► Address** option button to select the appropriate address for the adapter, or use the multipurpose knob. The default GPIB address is 1.
4. Run your GPIB software on your GPIB system.
5. If the oscilloscope and your GPIB system do not communicate, refer to the information on the software for your GPIB system, and to the user manual for the TEK-USB-488 adapter to resolve the problem.

## Command Entry

---

**NOTE.** For complete command information, refer to the *TDS2000C and TPS2000 Series Digital Oscilloscopes Programmer Manual, 077-0444-XX*.

---



## Connecting to a Printer

When you connect the oscilloscope to a PictBridge compatible printer, the oscilloscope and printer can be powered on or off. To connect the oscilloscope to a PictBridge compatible printer, follow these steps:

1. Insert one end of a USB cable into the USB Device port on the oscilloscope.
2. Insert the other end of the cable into the PictBridge port on a PictBridge compatible printer. Refer to the product documentation for your printer to locate the port.
3. To test the connection, set up the oscilloscope to print as described in the next procedure.

---

**NOTE.** *The printer recognizes the oscilloscope only when the printer is powered on.*

---

If the oscilloscope asks you to connect to a printer and a printer is connected, you need to power on the printer.

## Printing a Screen Image

To set up a PictBridge compatible printer, follow these steps:

1. Power on the oscilloscope and the printer.
2. Push the **Utility ► Options ► Printer Setup ► PRINT Button** and select the **Prints** option.
3. Set the **Ink Saver** option to **On**, the default setting.
4. Push the **- more - page 2 of 3** and **- more - page 3 of 3** option buttons to set up the printer. The oscilloscope queries the printer, and only displays options and values that the printer supports.

If you are not sure which setting to choose, select Default for each option.

5. To print a screen image, push the  print front panel button.

The oscilloscope takes a few seconds to capture the screen image. The settings of your printer and print speed determine how long it takes to print the data. Additional time may be required according to the format selected.

---

**NOTE.** *You can use the oscilloscope while the printer prints.*

---

6. If printing fails, check that the USB cable is connected to the PictBridge port on the printer, and try again.

---

**NOTE.** *The oscilloscope stores these settings until you change them, even if you push the **Default Setup** button, or you power off the oscilloscope.*

---

---

**NOTE.** *To stop sending the screen image to the printer, push **Abort Printing**.*

---

# Reference

This chapter describes the menus and operating details associated with each front-panel menu button or control.

## Acquire

Push the **Acquire** button to set acquisition parameters.

Options	Settings	Comments
Sample		Use to acquire and accurately display most waveforms; this is the default mode
Peak Detect		Use to detect glitches and reduce the possibility of aliasing
Average		Use to reduce random or uncorrelated noise in the signal display; the number of averages is selectable
Averages	4, 16, 64, 128	Select number of averages

### Key Points

If you probe a noisy square wave signal that contains intermittent, narrow glitches, the waveform displayed will vary depending on the acquisition mode you choose.

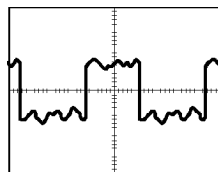

Sample

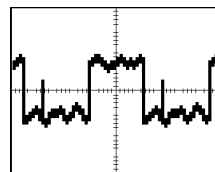

Peak Detect

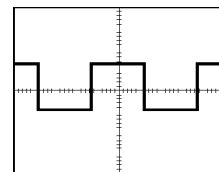

Average

**Sample.** Use Sample acquisition mode to acquire 2500 points and display them at the horizontal scale (seconds/division) setting. Sample mode is the default mode.

Sample acquisition intervals (2500)

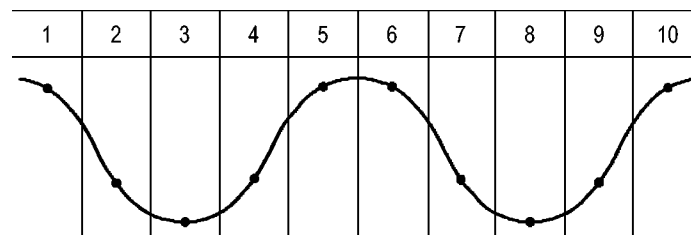

• Sample points

Sample mode acquires a single sample point in each interval.

The oscilloscope samples at the following rates:

- Maximum of 500 MS/s for 40 MHz and 50 MHz models
- Maximum of 1 GS/s for 60 MHz, 70 MHz or 100 MHz models
- Maximum of 2 GS/s for 200 MHz models

At 100 ns and faster settings, this sample rate does not acquire 2500 points. In this case, a Digital Signal Processor interpolates points between the sampled points to make a 2500 point waveform record.

**Peak Detect.** Use Peak Detect acquisition mode to detect glitches as narrow as 10 ns and to limit the possibility of aliasing. This mode is effective when at the horizontal scale setting of 5 ms/division or slower.

Peak Detect acquisition intervals (1250)

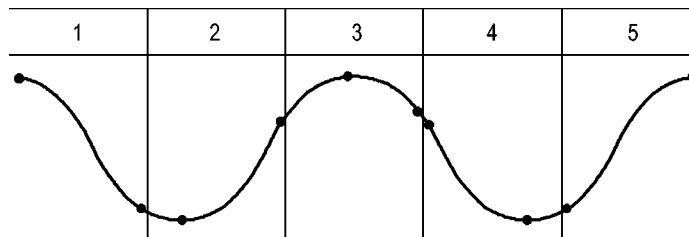

• Sample points displayed

Peak Detect mode displays the highest and lowest acquired voltage in each interval.

---

**NOTE.** If you set the horizontal scale (seconds/division) setting to 2.5 ms/div or faster, the acquisition mode changes to Sample because the sample rate is fast enough that Peak Detect is not necessary. The oscilloscope does not display a message to tell you that the mode was changed to Sample.

---

When there is enough waveform noise, a typical peak detect display shows large black areas. The oscilloscope displays this area with diagonal lines to improve display performance.



Typical peak detect display

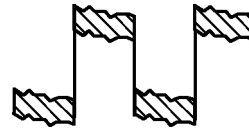

TDS2000C and TDS1000C-EDU peak detect display

**Average.** Use Average acquisition mode to reduce random or uncorrelated noise in the signal you want to display. Data is acquired in sample mode, then a number of waveforms are averaged together.

Select the number of acquisitions (4, 16, 64, or 128) to average for the waveform.

**Run/Stop Button.** Push the **Run/Stop** button when you want the oscilloscope to continuously acquire waveforms. Push the button again to stop the acquisition.

**Single Button.** Push the **Single** (single sequence) button when you want the oscilloscope to acquire a single waveform and then stop. Each time you push the **Single** button, the oscilloscope begins to acquire another waveform. After the oscilloscope detects a trigger it completes the acquisition and stops.

Acquisition mode	Single button
Sample, Peak Detect	Sequence is complete when one acquisition is acquired
Average	Sequence is complete when the defined number of acquisitions is reached; (See page 75, <i>Acquire</i> .)

**Scan Mode Display.** You can use the Horizontal Scan acquisition mode (also called Roll mode) to continuously monitor signals that change slowly. The oscilloscope displays waveform updates from the left to the right of the screen and erases old points as it displays new points. A moving, one-division-wide blank section of the screen separates the new waveform points from the old.

The oscilloscope changes to the Scan acquisition mode when you turn the **Horizontal Scale** knob to 100 ms/div or slower, and select the Auto Mode option in the Trigger Menu.

To disable Scan mode, push the **Trig Menu** button and set the Mode option to Normal.

**Stopping the Acquisition.** While the acquisition is running, the waveform display is live. Stopping the acquisition (when you push the **Run/Stop** button) freezes the display. In either mode, the waveform display can be scaled or positioned with the vertical and horizontal controls.

## Autorange

When you push the **AutoRange** button, the oscilloscope activates or deactivates the Autorange function. An LED light turns on adjacent to the **AutoRange** button that indicates when the function is active.

This function automatically adjusts setup values to track a signal. If the signal changes, the setup continues to track the signal. When you power on the oscilloscope, autoranging is always inactive.

Options	Comment
Autoranging	Activates or deactivates the Autorange function; when activated the adjacent LED light turns on
Vertical and Horizontal	Tracks and adjusts both axes
Vertical Only	Tracks and adjusts the Vertical scale; does not change the horizontal settings

Options	Comment
Horizontal Only	Tracks and adjusts the Horizontal scale; does not change the vertical settings
Undo Autoranging	Causes the oscilloscope to recall the previous setup

The following conditions cause autorange to adjust settings:

- Too many or too few waveform periods for a clear display of the trigger source (except when in Vertical Only)
- Waveform amplitude too large or too small (except when in Horizontal Only)
- Ideal trigger level changes

When you push the **AutoRange** button, the oscilloscope adjusts controls to produce a usable display of the input signal.

Function	Setting
Acquire mode	Sample
Display format	YT
Display persist	Off
Horizontal position	Adjusted
Horizontal view	Main
Run/Stop	RUN
Horizontal scale (seconds/division)	Adjusted
Trigger coupling	DC
Trigger holdoff	Minimum
Trigger level	Adjusted
Trigger mode	Edge
Vertical bandwidth	Full
Vertical BW limit	Off
Vertical coupling	DC
Vertical invert	Off
Vertical scale (volts/division)	Adjusted

The following changes to the setup of the oscilloscope deactivate autorange:

- Vertical scale deactivates vertical autoranging
- Horizontal scale deactivates horizontal autoranging
- Display or remove a channel waveform
- Trigger settings
- Single sequence acquisition mode
- Recall a setup

- XY Display format
- Persistence

The Autorange function is usually more useful than Autoset in the following situations:

- Analyzing a dynamically changing signal
- Quickly comparing a sequence of several signals without adjusting the oscilloscope. This is very useful if you need to use two probes at the same time, or if you need to use a probe in one hand and are holding something else in the other.
- Controlling which settings the oscilloscope automatically adjusts

If your signals vary in frequency, but have similar amplitudes, you can use Horizontal Only autoranging. The oscilloscope will adjust the horizontal settings, but leave the vertical settings unchanged. This way, you can visually estimate the amplitude of the signal without worrying about the vertical scale changing. Vertical Only autoranging works similarly, adjusting vertical parameters and leaving the horizontal settings unchanged.

## Autoset

When you push the **AutoSet** button, the oscilloscope identifies the type of waveform and adjusts controls to produce a usable display of the input signal.

Function	Setting
Acquire mode	Adjusted to Sample or Peak Detect
Cursors	Off
Display format	Set to YT
Display type	Set to Dots for a video signal, set to Vectors for an FFT spectrum; otherwise, unchanged
Horizontal position	Adjusted
Horizontal scale (seconds/division)	Adjusted
Trigger coupling	Adjusted to DC, Noise Reject, or HF Reject
Trigger holdoff	Minimum
Trigger level	Set to 50%
Trigger mode	Auto
Trigger source	Adjusted; refer to the information after this table; cannot use Autoset on the Ext Trig signal
Trigger slope	Adjusted
Trigger type	Edge or Video
Trigger Video Polarity	Normal

Function	Setting
Trigger Video Sync	Adjusted
Trigger Video Standard	Adjusted
Vertical bandwidth	Full
Vertical coupling	DC (if GND was previously selected); AC for a video signal; otherwise, unchanged
VOLTS/DIV	Adjusted

The Autoset function examines all channels for signals and displays corresponding waveforms. Autoset also determines the trigger source based on the following conditions:

- If multiple channels have signals, the oscilloscope displays the channel with the lowest frequency signal.
- If no signals are found, then the oscilloscope displays the lowest-numbered channel when Autoset was invoked.
- If no signals are found and no channels are displayed, then the oscilloscope displays and uses channel 1.



When you use Autoset and the oscilloscope cannot determine the signal type, the oscilloscope adjusts the horizontal and the vertical scales, then takes the Mean and Pk-to-Pk automatic measurements.

The Autoset function is usually more useful than Autorange in the following situations:

- Troubleshooting one stable signal
- Automatically seeing measurements of your signal
- Easily changing how the signal is presented. For example, viewing only one cycle of the waveform, or the rising edge of the waveform
- Viewing video signals or FFT signals

## Sine Wave

When you use the Autoset function and the oscilloscope determines that the signal is similar to a sine wave, the oscilloscope displays the following options:





Sine wave	Details
 Multi-cycle sine	Displays several cycles with appropriate vertical and horizontal scaling; the oscilloscope displays Cycle RMS, Frequency, Period, and Peak-to-Peak automatic measurements
 Single-cycle sine	Sets the horizontal scale to display about one cycle of the waveform; the oscilloscope displays Mean, and Peak-to-Peak automatic measurements



Sine wave	Details
 FFT	Converts the input time-domain signal into its frequency components and displays the result as a graph of frequency versus magnitude (spectrum); because this is a mathematical calculation, refer to the <i>Math FFT</i> chapter for more information
Undo Autoset	Causes the oscilloscope to recall the previous setup





## Square Wave or Pulse

When you use the Autoset function and the oscilloscope determines that the signal is similar to a square wave or pulse, the oscilloscope displays the following options:

Square wave or	Details
 Multi-cycle square	Displays several cycles with appropriate vertical and horizontal scaling; the oscilloscope displays Pk-Pk, Mean, Period, and Frequency automatic measurements
 Single-cycle square	Sets the horizontal scale to display about one cycle of the waveform; the oscilloscope displays Min, Max, Mean, and Positive Width automatic measurements
 Rising edge	Displays the edge, and the Rise Time and Peak-to-Peak automatic measurements
 Falling edge	Displays the edge, and the Fall Time and Peak-to-Peak automatic measurements
Undo Autoset	Causes the oscilloscope to recall the previous setup

## Video Signal

When you use the Autoset function and the oscilloscope determines that the signal is a video signal, the oscilloscope displays the following options:

Video signal options	Details
 Fields ► All Fields	Displays several fields and the oscilloscope triggers on any field
 Lines ► All Lines	Displays one complete line with parts of the previous and next line; the oscilloscope triggers on any line
 Lines ► Number	Displays one complete line with parts of the previous and next line; use the multipurpose knob to select a specific line number for the oscilloscope to use as a trigger
 Odd Fields	Displays several fields and the oscilloscope triggers only on odd numbered fields

Video signal options	Details
 Even Fields	Displays several fields and the oscilloscope triggers only on even numbered fields
Undo Autoset	Causes the oscilloscope to recall the previous setup

**NOTE.** Video autoset sets the Display Type option to Dot Mode.

## Cursor

Push the **Cursor** button to display the measurement cursors and Cursor Menu, and then use the multipurpose knob to change the position of a cursor.

Options	Settings	Comments
Type <sup>1</sup>	Time, Amplitude, Off	Select and display the measurement cursors; Time measures time, frequency, and amplitude; Amplitude measures amplitude, such as current or voltage
Source	CH1, CH2, CH3 <sup>2</sup> , CH4 <sup>2</sup> , MATH, REFA, REFB, REFC <sup>2</sup> , REFD <sup>2</sup>	Choose the waveform on which to take the cursor measurements Cursor readouts display the measurement
$\Delta$		Displays the absolute value of the difference (delta) between the cursors
Cursor 1 Cursor 2		Displays selected cursor location (time is referenced to the trigger position, and amplitude to the reference connection)

<sup>1</sup> For a Math FFT source, measures Frequency and Magnitude.

<sup>2</sup> Available only on a 4-channel oscilloscope.

Delta ( $\Delta$ ) values vary with the following types of cursors:

- Time cursors display  $\Delta t$ ,  $1/\Delta t$  and  $\Delta V$  (or  $\Delta I$ ,  $\Delta VV$ , and so on)
- Amplitude cursors, and Magnitude cursors (Math FFT source) display  $\Delta V$ ,  $\Delta I$ ,  $\Delta VV$ , and so on
- Frequency cursors (Math FFT source) display  $1/\Delta \text{Hz}$  and  $\Delta \text{dB}$

**NOTE.** The oscilloscope must display a waveform for the cursors and cursor readouts to appear.

**NOTE.** The oscilloscope displays the time and amplitude values for each waveform when you use Time cursors.

**Key Points** **Cursor Movement.** Use the multipurpose knob to move Cursor 1 or Cursor 2. You can move the cursors only while the Cursor Menu is displayed. The active cursor is represented by a solid line.

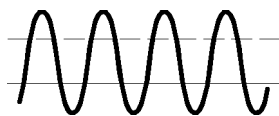

Amplitude cursors

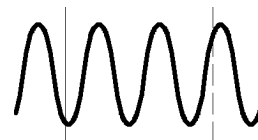

Time cursors

## Default Setup

Push the **Default Setup** button to recall most of the factory option and control settings, but not all. Appendix D lists the default settings that will be recalled.

## Display

Push the **Display** button to choose how waveforms are presented and to change the appearance of the entire display.

Options	Settings	Comments
Type	Vectors, Dots	Vectors fill the space between adjacent sample points in the display Dots display only the sample points
Persist	OFF, 1 sec, 2 sec, 5 sec, Infinite	Sets the length of time each displayed sample point remains displayed
Format	YT, XY	YT format displays the vertical voltage in relation to time (horizontal scale) XY format displays a dot each time a sample is acquired on channel 1 and channel 2 Channel 1 voltage or current determines the X coordinate of the dot (horizontal) and the channel 2 voltage or current determines the Y coordinate (vertical)

Depending on the type, waveforms will be displayed in three different styles: solid, dimmed, and broken.

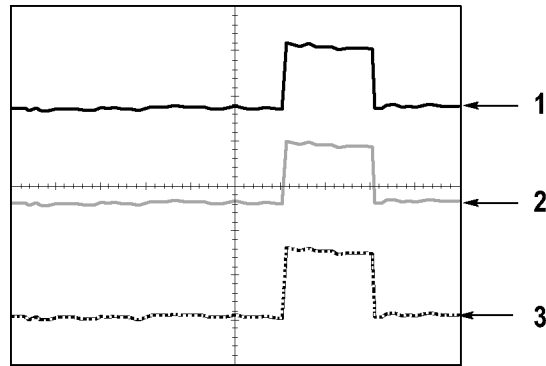

1. A solid waveform indicates a channel (live) waveform display. The waveform remains solid when the acquisition is stopped if no controls are changed that make the display accuracy uncertain.

Changing the vertical and horizontal controls is allowed on stopped acquisitions.

2. Reference waveforms appear white and waveforms with persistence applied appear in the same color as the Main waveform, but with less intensity.
3. A broken line indicates the waveform display no longer matches the controls. This happens when you stop the acquisition, and change a control setting that the oscilloscope is not able to apply to the displayed waveform. For example, changing the trigger controls on a stopped acquisition causes a broken-line waveform.

### Key Points

**Persistence.** The oscilloscope displays persistence waveform data with less intensity than "live" waveform data. With Persistence set to Infinite, record points accumulate until a control is changed.

Option	Comments
Off	Removes default or old waveforms whenever new waveforms display
Time limit	Displays new waveforms at normal intensity and old waveforms at a lower intensity; erases old waveforms when they reach the time limit
Infinite	Older waveforms become less bright but always remain visible; use Infinite persistence to look for infrequent events and to measure long term peak-to-peak noise

**XY Format.** Use the XY format to analyze phase differences, such as those represented by Lissajous patterns. The format plots the voltage on channel 1 against the voltage on channel 2, where channel 1 is the horizontal axis and

---

channel 2 is the vertical axis. The oscilloscope uses the untriggered Sample acquisition mode and displays data as dots. The sampling rate is fixed at 1 MS/s.

---

**NOTE.** *The oscilloscope can capture a waveform in normal YT mode at any sampling rate. You can view the same waveform in XY mode. To do so, stop the acquisition and change the display format to XY.*

---

In XY format, the controls operate as follows:

- The channel 1 **Vertical Scale** and **Vertical Position** controls set the horizontal scale and position.
- The channel 2 **Vertical Scale** and **Vertical Position** controls continue to set vertical scale and position.

The following functions do not work in XY display format:

- Autoset (resets display format to YT)
- Autorange
- Automatic measurements
- Cursors
- Reference or Math waveforms
- Save/Recall ► Save All
- Time base controls
- Trigger controls

## Help

Push the **Help** button to display the Help menu. The topics cover all the menu options and controls of the oscilloscope. (See page xiv, *Help System*.)

## Horizontal

You can use the horizontal controls to set up two views of a waveform, each with their own horizontal scale and position. The horizontal position readout shows the time represented by the center of the screen, using the time of the trigger as zero. When you change the horizontal scale, the waveform will expand or contract around the screen center.

Options	Comments
Main	The main horizontal time base setting is used to display the waveform
Window Zone	Two cursors define a window zone Adjust the window zone with the <b>Horizontal Position</b> and <b>Horizontal Scale</b> controls
Window	Changes the display to show the waveform segment (expanded to screen width) within the window zone
Set Holdoff	Displays the holdoff value; push the option button and use the multipurpose knob to adjust

**NOTE.** You can push the horizontal option buttons to switch between an entire waveform display and a zoomed part of it.

A readout near the top right of the screen displays the current horizontal position in seconds. An **M** indicates the Main time base and a **W** indicates the Window time base. The oscilloscope also indicates horizontal position with an arrow icon at the top of the graticule.

### Knobs and Buttons

**Horizontal Position Knob.** Use to control the position of the trigger relative to the center of the screen.

The trigger point can be set to the left or the right of the center of the screen. The maximum number of divisions to the left depends on the Horizontal Scale (time base) setting. For most scales, the maximum is at least 100 divisions. Placing the trigger point off the screen to the left is called Delayed Sweep.

**Set To Zero Button.** Use to set the horizontal position to zero.

**Horizontal Scale Knob (seconds/division).** Use to change the horizontal time scale to magnify or compress the waveform.

**Key Points**

**Horizontal Scale.** If waveform acquisition is stopped (using the **Run/Stop** or **Single** button), the **Horizontal Scale** control expands or compresses the waveform. Use to zoom in on a detail of the waveform.

**Scan Mode Display (Roll Mode).** When the **Horizontal Scale** control is set to 100 ms/div or slower and the trigger mode is set to Auto, the oscilloscope enters the Scan acquisition mode. In this mode, the waveform display updates from left to right. There is no trigger or horizontal position control of waveforms during scan mode. (See page 77, *Scan Mode Display*.)

**Window Zone.** Use the window zone option to define a segment of a waveform to see in more detail (zoom). The Window time base setting cannot be set slower than the Main time base setting.

Vertical bars define Window Zone

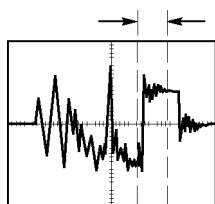

Main time base displayed

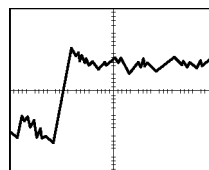

Window zone displayed

**Window.** Expands the Window Zone to cover the entire screen. Use to change between two time bases.

---

**NOTE.** When you change between the Main, Window Zone, and Window views, the oscilloscope erases any waveform saved on the screen through persistence. Persistence is erased with Horizontal menu changes.

---

**Holdoff.** Use holdoff to help stabilize the display of complex waveforms. (See page 101, *Holdoff*.)

## Math

Push the **Math** button to display waveform math operations. Push the **Math** button again to remove math waveforms. (See page 104, *Vertical Controls*.)

Options	Comments
+, -, x, FFT	Math operations; see the next table
Sources	Sources used for the operations; see the next table

Options	Comments
Position	Use the multipurpose knob to set the vertical position of the resultant Math waveform
Vertical Scale	Use the multipurpose knob to set the vertical scale of the resultant Math waveform

The Math Menu includes Sources options for each operation.

Operation	Sources option	Comments
+ (addition)	CH1 + CH2	Channels 1 and 2 are added together
	CH3 + CH4 <sup>1</sup>	Channels 3 and 4 are added together
- (subtraction)	CH1 - CH2	The channel 2 waveform is subtracted from the channel 1 waveform
	CH2 - CH1	The channel 1 waveform is subtracted from the channel 2 waveform
	CH3 - CH4 <sup>1</sup>	The channel 4 waveform is subtracted from the channel 3 waveform
	CH4 - CH3 <sup>1</sup>	The channel 3 waveform is subtracted from the channel 4 waveform
× (multiplication)	CH1×CH2	Channels 1 and 2 are multiplied together
	CH3×CH4 <sup>1</sup>	Channels 3 and 4 are multiplied together
FFT	(See page 55.)	

<sup>1</sup> Available only on a 4-channel oscilloscope.

## Key Points

**Waveform Units.** The combination of source waveform units determine the resulting units for the Math waveform.

Waveform unit	Waveform unit	Operation	Resulting Math unit
V	V	+ or -	V
A	A	+ or -	A
V	A	+ or -	?
V	V	×	VV
A	A	×	AA
V	A	×	VA



## Measure

Push the **Measure** button to access automatic measurements. There are sixteen types of measurements available. You can display up to five at a time.

Push the top option button to display the Measure 1 Menu. You can choose the channel on which to take a measurement in the Source option. You can choose the type of measurement to take in the Type option. Push the Back option button to return to the Measure Menu and display the selected measurements.

**Key Points** **Taking Measurements.** You can display up to five automatic measurements at a time. The waveform channel must be on (displayed) to make a measurement.

Automated measurements cannot be taken on reference waveforms, or while using XY or scan mode. The measurements update about two times per second.

Measurement type	Definition
<b>Freq</b>	Calculates the frequency of the waveform by measuring the first cycle
<b>Period</b>	Calculates the time of the first cycle
<b>Mean</b>	Calculates the arithmetic mean amplitude over the entire record
<b>Pk-Pk</b>	Calculates the absolute difference between the maximum and minimum peaks of the entire waveform
<b>Cyc RMS</b>	Calculates a true RMS measurement of the first complete cycle of the waveform
<b>RMS</b>	Calculates a true RMS measurement for all 2,500 samples from one frame of the waveform data
<b>Cursor RMS</b>	Calculates a true RMS measurement of the waveform data from the selected starting to the ending point
<b>Min</b>	Examines the entire 2500 point waveform record and displays the minimum value
<b>Max</b>	Examines the entire 2500 point waveform record and displays the maximum value
<b>Rise Time</b>	Measures the time between 10% and 90% of the first rising edge of the waveform
<b>Fall Time</b>	Measures the time between 90% and 10% of the first falling edge of the waveform
<b>Pos Width</b>	Measures the time between the first rising edge and the next falling edge at the waveform 50% level
<b>Neg Width</b>	Measures the time between the first falling edge and the next rising edge at the waveform 50% level
<b>Duty Cyc</b>	Measures the ratio of the positive pulse duration to the whole cycle
<b>Phase</b>	Calculates the phase angle difference of signals from two different channels, using the rising edge of the first signal compared to the rising edge of the second signal
<b>Delay</b>	Calculates the time difference from two different channels using the rising edge of the first signal compared to the rising edge of the second signal.
<b>None</b>	Does not take any measurement

## Print

When the **Save All ► PRINT Button** option is set to **Prints**, you can push the  print button to send the screen image to a printer.

You can set up the oscilloscope to send a screen image to your printer through the **Utility ► Options ► Printer Setup** menu.

Option	Setting	Comments
Ink Saver	On, Off	Prints the screen image on a white background when you select On
Layout <sup>1</sup>	Portrait, Landscape	Printer output orientation
Abort Printing		Stops sending the screen image to the printer
Paper Size <sup>2</sup>	Default, L, 2L, Hagaki Postcard, Card Size, 10 x 15 cm, 4" x 6", 8" x 10", Letter, 11" x 17", A0, A1, A2, A3, A4, A5, A6, A7, A8, A9, B0, B1, B2, B3, B4, B5, B6, B7, B8, B9, 89 mm Roll (L), 127 mm Roll (2L), 100 mm Roll (4"), 210 mm Roll (A4)	Displays settings available on your PictBridge compatible printer
Image Size <sup>2</sup>	Default, 2.5 x 3.25 in, L (3.5 x 5 in), 4 x 6 in, 2L (5 x 7 in), 8 x 10 in, 4L (7 x 10 in), E, Card, Hagaki card, 6 x 8 cm, 7 x 10 cm, 9 x 13 cm, 10 x 15 cm, 13 x 18 cm, 15 x 21 cm, 18 x 24 cm, A4, Letter	
Paper Type <sup>2</sup>	Default, Plain, Photo, Fast Photo	
Print Quality <sup>2</sup>	Default, Normal, Draft, Fine	
Date Print <sup>2</sup>	Default, Off, On	
ID Print <sup>2</sup>	Default, Off, On	

<sup>1</sup> The printer may override your selection for best fit.

<sup>2</sup> If your selection is not supported by the printer, the oscilloscope uses the Default setting.

The alternative function of the print button is to save data to a USB flash drive. (See page 63, *USB Flash Drive and Device Ports*.)

The oscilloscope was designed to print to any PictBridge compatible printer. Refer to the product documentation for your printer to determine if the printer is PictBridge compatible.

## Probe Check

You can use the Probe Check Wizard to quickly verify that your voltage probe is operating properly. (See page 5, *Voltage Probe Check Wizard*.)

## Reference Menu

The Reference menu can turn on or turn off reference memory waveforms from the display. The waveforms are stored in the non-volatile memory of the oscilloscope, and have the following designations: RefA, RefB, RefC, and RefD. (RefC and RefD are only available on 4-channel oscilloscopes.)

To display (recall) or hide a reference waveform, follow these steps:

1. Push the **Ref** front panel button.
2. Push the side-menu button corresponding to the reference waveform you wish to display or hide.

Reference waveforms have the following characteristics:

- Reference waveforms are displayed in white
- Two reference waveforms can be displayed at the same time
- Vertical and horizontal scale readouts display at the bottom of the screen
- Reference waveforms cannot be zoomed or panned

You can display one or two reference waveforms at the same time as "live" channel waveforms. If you display two reference waveforms, you must hide one waveform before you can display a different one.

Refer to *Save Waveform* for information on how to save reference waveforms. (See page 94, *Save Waveform*.)

## Save/Recall

Push the **Save/Recall** button to save oscilloscope setups, screen images, or waveforms, or to recall oscilloscope setups or waveforms.

The Save/Recall menu is made up of many submenus which you can access through an Action option. Each Action option displays a menu that allows you to further define the save or recall function.

Action options	Comments
Save All	Contains the option that configures the PRINT button to send data to a printer or to save data to a USB flash drive
Save Image	Saves a screen image to a file in a specified format

Action options	Comments
Save Setup	Saves the current oscilloscope settings to a file in a specified folder or in nonvolatile setup memory
Save Waveform	Saves the specified waveform to a file or to reference memory
Recall Setup	Recalls an oscilloscope setup file from a USB flash drive or from a location in nonvolatile setup memory
Recall Waveform	Recalls a waveform file from a USB flash drive to reference memory

**Save All** The Save All action configures the PRINT button to save data to a USB flash drive, or to send data to a printer.

Options	Settings or submenus	Comments
PRINT Button	Saves All to Files <sup>1</sup>	(See page 67.)
	Saves Image to File <sup>1</sup>	(See page 68.)
	Prints	(See page 73.)
Select Folder		Lists the contents of the current USB flash drive folder
	Change Folder	(See page 64, <i>File Management Conventions</i> .) (See page 103, <i>File Utilities for the USB Flash Drive</i> .)
	New Folder	(See page 103, <i>File Utilities for the USB Flash Drive</i> .)
	Back	Returns to the Save All menu
About Save All		Displays the help topic

<sup>1</sup> An LED lights adjacent to the PRINT button to indicate the alternative Save function that sends data to a USB flash drive.

**Save Image** The Save Image action saves a screen image to a file in a specified format.

Options	Settings or submenus	Comments
File Format	BMP, PCX, TIFF, RLE, EPSIMAGE, JPEG	Sets the screen image graphics file format
About Saving Images		Displays the help topic

Options	Settings or submenus	Comments
Select Folder		Lists the contents of the current USB flash drive folder and displays the folder options
	Change Folder	(See page 64, <i>File Management Conventions</i> .) (See page 103, <i>File Utilities for the USB Flash Drive</i> .)
	New Folder	
	Layout <sup>1</sup> , Portrait, Landscape	Select portrait or landscape image layout
	Ink Saver <sup>1</sup> , On, Off	Activates or deactivates Ink Saver mode
Save	filename (such as TEK0000.TIF)	Saves the screen image to the automatically generated file name in the current USB flash drive folder

<sup>1</sup> (See page 90, *Print*.)

When the print button option is set to Saves Image to File, the oscilloscope saves screen images to a USB flash drive when you push the Save button. (See page 68, *Saves Image to File*.)

## Save Setup

The Save Setup action saves the current oscilloscope settings to a file named TEKnmmn.SET in a specified folder, or in nonvolatile setup memory. A setup file contains an ASCII text string that lists the oscilloscope settings.

Options	Settings or submenus	Comments
Save To	Setup	Saves the current oscilloscope settings to a location in the nonvolatile setup memory
	File	Saves the current oscilloscope settings to a file on the USB flash drive
Setup	1 to 10	Specifies which nonvolatile setup memory location to save to
Select Folder		Lists the contents of the current USB flash drive folder
	Change Folder	(See page 64, <i>File Management Conventions</i> .) (See page 103, <i>File Utilities for the USB Flash Drive</i> .)
	New Folder	
Save	filename (such as TEK0000.SET)	Saves the settings to the automatically generated file name in the current USB flash drive folder

When the print button option is set to Saves All to Files, the oscilloscope saves oscilloscope setup files to a USB flash drive when you push the Save button. (See page 67, *Saves All to Files*.)

**Save Waveform**

The Save Waveform action saves the specified waveform to a file named TEKnnnn.CSV, or to reference memory. The oscilloscope saves waveform data to files as "comma separated values" (.CSV format), which are ASCII text strings that list the time (relative to the trigger) and amplitude values for each of the 2500 waveform data points. You can import .CSV files into many spreadsheet and math analysis applications.

Options	Settings or submenus	Comments
Save To	File	Specifies to save the source waveform data to a file on a USB flash drive
	Ref	Specifies to save the source waveform data in reference memory
Source <sup>1</sup>	CH(x), Ref(x), MATH	Specifies which source waveform to save
To	Ref(x)	Specifies the reference memory location in which to save the source waveform
Select Folder		Lists the contents of the current USB flash drive folder
	Change Folder	(See page 64, <i>File Management Conventions.</i> ) (See page 103, <i>File Utilities for the USB Flash Drive.</i> )
	New Folder	
Save	filename (such as TEK0000.CSV)	Saves the waveform data to the automatically generated file name in the current USB flash drive folder

<sup>1</sup> Waveform must be displayed to save it as a reference waveform.

**Recall Setup**

The Recall Setup action recalls an oscilloscope setup file from a USB flash drive or from a location in nonvolatile setup memory.

Options	Settings or submenus	Comments
Recall From	Setup	Specifies to recall a setup from the nonvolatile memory
	File	Specifies to recall a setup file from a USB flash drive
Setup	1 to 10	Specifies which setup location in nonvolatile setup memory to recall
Select File		Lists the contents of the current USB flash drive folder to select a file from
	Change Folder	(See page 64, <i>File Management Conventions.</i> ) (See page 103, <i>File Utilities for the USB Flash Drive.</i> )
Recall		Recalls the settings from the specified nonvolatile memory location
	filename (such as TEK0000.SET)	Recalls the oscilloscope settings from the specified USB flash drive file

**Recall Waveform** The Recall Waveform action recalls a waveform file from a USB flash drive to a location in reference memory.

Options	Settings or submenus	Comments
To	Ref(x)	Specifies the reference memory location to load the waveform to
From File		Recalls the file from the USB flash drive
Select File		Lists the contents of the current USB flash drive folder and displays the next folder option
	Change Folder	(See page 64, <i>File Management Conventions</i> .) (See page 103, <i>File Utilities for the USB Flash Drive</i> .)
	To	Specifies the reference memory location to recall the waveform to
Recall	filename (such as TEK0000.CSV)	Loads the waveform from the specified file to the location in reference memory and displays the waveform

**Key Points** **Saving and Recalling Setups.** The complete setup is stored in nonvolatile memory. When you recall the setup, the oscilloscope will be in the mode from which the setup was saved.

The oscilloscope saves the current setup if you wait three seconds after the last change before you power off the oscilloscope. The oscilloscope then recalls this setup the next time you apply power.

**Recalling the Default Setup.** You can push the **Default Setup** button to initialize the oscilloscope to a known setup. To view option and control settings that the oscilloscope recalls when you push this button, refer to *Appendix D: Default Setup*.

**Saving and Recalling Waveforms.** The oscilloscope must display any waveform that you want to save. Two-channel oscilloscopes can store two reference waveforms in internal nonvolatile memory. Four-channel oscilloscopes can store four, but only display two at a time.

The oscilloscope can display both reference waveforms and channel waveform acquisitions. Reference waveforms are not adjustable, but the oscilloscope displays the horizontal and vertical scales at the bottom of the screen.

## Trigger Controls

You can define the trigger through the Trigger Menu and front-panel controls.

### Trigger Types

Three types of triggering are available: Edge, Video, and Pulse Width. A different set of options display for each type of trigger.

Option	Details
Edge (default)	Triggers the oscilloscope on the rising or falling edge of the input signal when it crosses the trigger level (threshold)
Video	Displays NTSC or PAL/SECAM standard composite video waveforms; you trigger on fields or lines of video signals. (See page 98, <i>Video Trigger</i> .)
Pulse	Triggers on aberrant pulses. (See page 99, <i>Pulse Width Trigger</i> .)

### Edge Trigger

Use Edge triggering to trigger on the edge of the oscilloscope input signal at the trigger threshold.

Options	Settings	Comments
Edge		With Edge highlighted, the rising or falling edge of the input signal is used for the trigger
Source	CH1, CH2, CH3 <sup>1</sup> , CH4 <sup>1</sup> , Ext, Ext/5, AC Line	Select the input source as the trigger signal (See page 97.)
Slope	Rising, Falling	Select to trigger on either the rising or falling edge of the signal
Mode	Auto, Normal	Select the type of triggering (See page 96.)
Coupling	AC, DC, Noise Reject, HF Reject, LF Reject	Selects the components of the trigger signal applied to the trigger circuitry (See page 97.)

<sup>1</sup> Available only on a 4-channel oscilloscope.

### Trigger Frequency Readout

The oscilloscope counts the rate at which triggerable events occur to determine trigger frequency and displays the frequency in the lower right corner of the screen.

**NOTE.** *The trigger frequency readout shows the frequency of events the oscilloscope might consider to be a trigger, and may be less than the frequency of the input signal in Pulse Width trigger mode.*

### Key Points

**Mode Options.** The Auto mode (default) forces the oscilloscope to trigger when it does not detect a trigger within a certain amount of time based on the horizontal



scale setting. You can use this mode in many situations, such as to monitor the level of a power supply output.

Use the Auto mode to let the acquisition free-run in the absence of a valid trigger. This mode allows an untriggered, scanning waveform at 100 ms/div or slower time base settings.

The Normal mode updates displayed waveforms only when the oscilloscope detects a valid trigger condition. The oscilloscope displays older waveforms until the oscilloscope replaces them with new ones.

Use the Normal mode when you want to see only valid triggered waveforms. When you use this mode, the oscilloscope does not display a waveform until after the first trigger.

To perform a Single Sequence acquisition, push the **Single** button.

### Source Options.

Source option	Details
CH1, CH2, CH3 <sup>1</sup> , CH4 <sup>1</sup>	Triggers on a channel whether or not the waveform is displayed
Ext	Does not display the trigger signal; the Ext option uses the signal connected to the Ext Trig front-panel BNC and allows a trigger level range of +1.6 V to -1.6 V
Ext/5	Same as Ext option, but attenuates the signal by a factor of five, and allows a trigger level range of +8 V to -8 V; this extends the trigger level range
AC Line <sup>2</sup>	Uses a signal derived from the power line as the trigger source; trigger coupling is set to DC and the trigger level to 0 volts. You can use the AC Line when you need to analyze signals related to the frequency of the power line, such as lighting equipment and power supply devices; the oscilloscope automatically generates the trigger, sets the Trigger Coupling to DC, and sets the Trigger Level to zero volts.

<sup>1</sup> Available only on a 4-channel oscilloscope.

<sup>2</sup> Available only when you select the Edge trigger type.

**NOTE.** To view an Ext, Ext/5, or AC Line trigger signal, push and hold down the **Trig View** button.

**Coupling.** Coupling allows you to filter the trigger signal used to trigger an acquisition.

Option	Details
DC	Passes all components of the signal
Noise Reject	Adds hysteresis to the trigger circuitry; this reduces sensitivity which reduces the chance of falsely triggering on noise

Option	Details
HF Reject	Attenuates the high-frequency components above 80 kHz
LF Reject	Blocks the DC component and attenuates the low-frequency components below 300 kHz
AC	Blocks DC components and attenuates signals below 10 Hz

**NOTE.** *Trigger coupling affects only the signal passed to the trigger system. It does not affect the bandwidth or coupling of the signal displayed on the screen.*

**Pretrigger.** The trigger position is typically set at the horizontal center of the screen. In this case, you are able to view five divisions of pretrigger information. Adjusting the Horizontal Position of the waveform allows you to see more or less pretrigger information.

## Video Trigger

Options	Settings	Comments
Video		With Video highlighted, triggering occurs on an NTSC, PAL, or SECAM standard video signal Trigger coupling is preset to AC
Source	CH1, CH2, CH3 <sup>1</sup> , CH4 <sup>1</sup> , Ext, Ext/5	Selects the input source as the trigger signal; Ext and Ext/5 selections use the signal applied to the Ext Trig connector
Polarity	Normal, Inverted	Normal triggers on the negative edge of the sync pulse; Inverted triggers on the positive edge of the sync pulse
Sync	All Lines, Line Number, Odd Field, Even Field, All Fields	Select an appropriate video sync Use the multipurpose knob to specify a line number when you select Line Number for the Sync option
Standard	NTSC, PAL/SECAM	Select the video standard for sync and line number count

<sup>1</sup> Available only on a 4-channel oscilloscope.

## Key Points

**Sync Pulses.** When you choose Normal Polarity, the trigger always occurs on negative-going sync pulses. If your video signal has positive-going sync pulses, use the Inverted Polarity selection.

**Pulse Width Trigger** Use Pulse Width triggering to trigger on normal or aberrant pulses.

Options	Settings	Comments
Pulse		With Pulse highlighted, triggering occurs on pulses that meet the trigger condition defined by the Source, When, and Set Pulse Width options
Source	CH1, CH2, CH3 <sup>1</sup> , CH 4 <sup>1</sup> , Ext, Ext/5	Select the input source as the trigger signal
When	=, ≠, <, >	Select how to compare the trigger pulse relative to the value selected in the Pulse Width option
Pulse Width	33 ns to 10.0 sec	Use the multipurpose knob to set a width
Polarity	Positive, Negative	Select to trigger on positive or negative pulses
Mode	Auto, Normal	Select the type of triggering; Normal mode is best for most Pulse Width trigger applications
Coupling	AC, DC, Noise Reject, HF Reject, LF Reject	Selects the components of the trigger signal applied to the trigger circuitry; (See page 96, <i>Edge Trigger</i> .)
More		Use to switch between submenu pages

<sup>1</sup> Available only on a 4-channel oscilloscope.

**Trigger Frequency Readout** The oscilloscope counts the rate at which trigger events occur to determine trigger frequency and displays the frequency in the lower right corner of the screen.

**Key Points** **Trigger When.** The pulse width of the source must be  $\geq 5$  ns for the oscilloscope to detect the pulse.

When options	Details
=	Triggers the oscilloscope when the signal pulse width is equal to or not equal to the specified pulse width within a $\pm 5\%$ tolerance
≠	
<	Triggers the oscilloscope when the source signal pulse width is less than or greater than the specified pulse width
>	

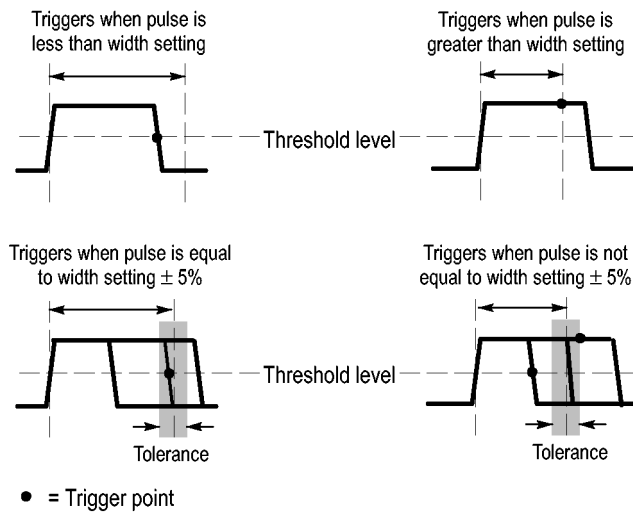

Refer to the *Application Examples* chapter for an example of triggering on aberrant pulses. (See page 44, *Triggering on a Specific Pulse Width*.)

## Knobs and Buttons

**Level Knob.** Use to control the Trigger Level.

**Set To 50% Button.** Use the **Set To 50%** button to quickly stabilize a waveform. The oscilloscope automatically sets the Trigger Level to be about halfway between the minimum and maximum voltage levels. This is useful when you connect a signal to the Ext Trig BNC and set the trigger source to Ext, or Ext/5.

**Force Trig Button.** Use the **Force Trig** button to complete the waveform acquisition whether or not the oscilloscope detects a trigger. This is useful for single sequence acquisitions and Normal trigger mode. (In Auto trigger mode, the oscilloscope automatically forces triggers periodically if it does not detect a trigger.)

**Trig View Button.** Use the Trigger View mode to display the conditioned trigger signal on the oscilloscope. You can use this mode to see the following types of information:

- Effects of the Trigger Coupling option
- AC Line trigger source (Edge Trigger only)
- Signal connected to the Ext Trig BNC

---

**NOTE.** This is the only button that you must hold down to use. When you hold down the **Trig View** button, the only other button you can use is the  print button. The oscilloscope disables all other front-panel buttons. The knobs continue to be active.

---

**Holdoff.** You can use the Trigger Holdoff function to produce a stable display of complex waveforms, such as pulse trains. Holdoff is the time between when the oscilloscope detects one trigger and when it is ready to detect another. The oscilloscope will not trigger during the holdoff time. For a pulse train, you can adjust the holdoff time so the oscilloscope triggers only on the first pulse in the train.

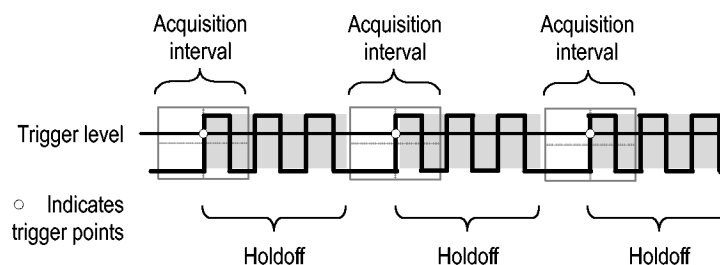

Triggers are not recognized during holdoff time.

To use Trigger Holdoff, push the **Horiz ► Set Trigger Holdoff** option button and use the multipurpose knob to adjust the holdoff. The resolution of the trigger holdoff varies depending on the horizontal scale setting.

## Utility

Push the **Utility** button to display the Utility Menu.

Options	Settings	Comments
Limit Test (Not available on TDS1000C-EDU models)	Source	Defines the source of the waveforms against which to run the template waveform
	Compare To	Specifies the limit test template against which to compare the signals defined with the Source menu item.
	Run/Stop Test	Toggles between whether to start or stop the limit test
	Template Setup	Sets up a limit test waveform template. This is the mask signal you define as the boundary to compare with the input source signal. Do this before running a limit test
	Action on Violation	Defines the actions the oscilloscope will take after detecting a violation
	Stop After	Defines the conditions that will cause the oscilloscope to end limit testing
Data Logging (Not available on TDS1000C-EDU models)	Data Logging	Sets the data logging feature on or off
	Source	Sets the signal source to log data from
	Duration	Sets the time duration of data logging in half hour increments, from 0.5 hour to 8 hours, or in one hour increments, from 8 hours to 24 hours, or to indefinite
	Select Folder	Sets the folder to save the waveform data to

Options	Settings	Comments
System Status		Summary of the oscilloscope settings
	Misc.	Displays model, manufacturer serial number, adapters connected, GPIB setup address, firmware version, and other information
Options	Printer Setup	Changes the printer setup (See page 73.)
	GPIB Setup ► Address	Sets the GPIB address for the TEK-USB-488 adapter (See page 72.)
	Set Date and Time	Sets the date and time (See page 102.)
	Error Log	Displays a list of any errors logged and the Power Cycle count This log is useful if you contact a Tektronix Service Center for help.
Do Self Cal		Performs a self calibration
File Utilities		Displays folder, file, and USB flash drive options (See page 103.)
Language	English, French, German, Italian, Spanish, Japanese, Portuguese, Simplified Chinese, Traditional Chinese, Korean	Selects the display language of the oscilloscope

**Key Points** **System Status.** Selecting System Status from the Utility Menu displays the menus available for obtaining a list of control settings for each group of oscilloscope controls.

Push any front-panel menu button to remove the status screen.

Options	Comments
Horizontal	Lists horizontal parameters
Vertical	Lists vertical parameters of channels
Trigger	Lists trigger parameters
Misc	Lists the model of the oscilloscope, the version number of the software, and the serial number Lists values of the communications parameters

**Setting the Date and Time.** You can use the Set Date and Time menu to set the clock date and time. The oscilloscope displays this information, and also uses it to time stamp files written to a USB flash drive. The oscilloscope contains a built-in nonreplaceable battery to maintain the clock settings.

The clock does not automatically adjust for seasonal time changes. The calendar does adjust for Leap years.

Options	Comments
↑ ↓	Moves the field selection highlight up or down through the list. Use the multipurpose knob to change the value of the selected field
Set Date and Time	Updates the oscilloscope with the specified date and time
Cancel	Closes the menu and returns to the previous menu without saving any changes

**Self Calibration.** The self calibration routine optimizes the oscilloscope accuracy for the ambient temperature. For maximum accuracy, perform a self cal if the ambient temperature changes by 5 °C (9 °F ) or more. For accurate calibration, power on the oscilloscope and wait twenty minutes to ensure it is warmed up. Follow the directions on the screen.

Factory calibration uses externally-generated voltages, and requires specialized equipment. The recommended interval is one year. See *Contacting Tektronix* on the copyright page for information on having Tektronix perform a Factory Calibration of your oscilloscope.

## File Utilities for the USB Flash Drive

One folder is always designated as the current folder. The current folder is the default location to save and recall files.

You can use the File Utilities menu to do the following tasks:

- List the contents of the current folder
- Select a file or folder
- Navigate to other folders
- Create, rename, and delete files and folders
- Format a USB flash drive

Options	Comments
Change Folder	Navigates to the selected USB flash drive folder. Use the multipurpose knob to select a file or folder, then select the Change Folder menu option.  To return to the previous folder, select the ↑Up folder item and then select the Change Folder menu option.
New Folder	Creates a new folder in the current folder location, named NEW_FOL, and displays the Rename menu for changing the default folder name.
Rename (filename or folder)	Displays the Rename screen to rename a folder or file, described next.
Delete (filename or folder)	Deletes the selected file name or folder; a folder must be empty before you can delete it.

Options	Comments
Confirm Delete	Displays after pressing Delete, to confirm a file delete action. Pressing any button or knob other than Confirm Delete cancels the file delete action.
Format	Formats the USB flash drive; this deletes all data on the USB flash drive.
Update Firmware	Follow the on-screen directions to set up and push the Update Firmware option button to start updating firmware.

**Rename File or Folder.** You can change the names of files and folders on a USB flash drive.

Option	Settings	Comments
Enter Character	A - Z, 0 - 9, _, .	Enters the highlighted alphanumeric character at the current Name field cursor position
	Backspace	Use the multipurpose knob to select an alphanumeric character or the Backspace, Delete Character, or Clear Name functions
	Delete	Changes the menu button 1 option to the Backspace function. Deletes the character to the left of the highlighted character in the Name field
	Clear Name	Changes the menu button 1 option to the Delete Character function. Deletes the highlighted character from the Name field
	Clear Name	Changes the menu button 1 option to Clear Name. Deletes all characters from the Name field

## Vertical Controls

You can use the vertical controls to display and remove waveforms, adjust vertical scale and position, set input parameters, and for vertical math operations. (See page 87, *Math*.)

### Channel Vertical Menus

There is a separate vertical menu for each channel. Each option is set individually for each channel.

Options	Settings	Comments
Coupling	DC, AC, Ground	DC passes both AC and DC components of the input signal
		AC blocks the DC component of the input signal and attenuates signals below 10 Hz
		Ground disconnects the input signal



Options	Settings	Comments
BW Limit	20 MHz <sup>1</sup> , Off	Limits the bandwidth to reduce display noise; filters the signal to reduce noise and other unwanted high frequency components
Volts/Div	Coarse, Fine	Selects the resolution of the Scale (Volts/Div) knob Coarse defines a 1-2-5 sequence. Fine changes the resolution to small steps between the coarse settings
Probe	See the next table	Push to adjust Probe options
Invert	On, Off	Inverts (flips) the waveform with respect to the reference level

<sup>1</sup> Effective bandwidth is 6 MHz with a P2220 probe set to 1X.

The option for voltage and current probes is different: Attenuation or Scale.

Probe options	Settings	Comments
Probe ► Voltage ► Attenuation	1X, 10X, 20X, 50X, 100X, 500X, 1000X	Set to match the attenuation factor of the voltage probe to ensure correct vertical readouts
Probe ► Current ► Scale	5 V/A, 1 V/A, 500 mV/A, 200 mV/A, 100 mV/A, 20 mV/A, 10 mV/A, 1 mV/A	Set to match the scale of the current probe to ensure correct vertical readouts
Back		Returns to the previous menu

**Knobs** **Vertical Position Knobs.** Use the **Vertical Position** knobs to move the channel waveforms up or down on the screen.

**Vertical Scale (volts/division) Knobs.** Use the **Vertical Scale** knobs to control how the oscilloscope amplifies or attenuates the source signal of channel waveforms. When you turn a **Vertical Scale** knob, the oscilloscope increases or decreases the vertical size of the waveform on the screen.

**Vertical Measurement Overrange (Clipping).** Waveforms that extend beyond the screen (overrange) and display a ? in the measurement readout indicates an invalid value. Adjust the vertical scaling to ensure the readout is valid.

**Key Points** **Ground Coupling.** Use Ground coupling to display a zero-volt waveform. Internally, the channel input is connected to a zero-volt reference level.

**Fine Resolution.** The vertical scale readout displays the actual volts/division setting while in the fine resolution setting. Changing the setting to coarse does not change the vertical scale until the **Vertical Scale** control is adjusted.

**Remove Waveform.** To remove a waveform from the display, push a channel menu front panel button. For example, push the **1** (channel 1 menu) button to display or remove the channel 1 waveform.

---

**NOTE.** *You do not have to display a channel waveform to use it as a trigger source or for math operations.*

---

---

**NOTE.** *You must display a channel waveform to take measurements from it, use cursors on it, or to save it as a Reference waveform or to a file.*

---

# Appendix A: Specifications

All specifications apply to the TDS2000C and TDS1000C-EDU series models. TPP0101 and TPP0201 probe specifications appear in Appendix B. To verify that the oscilloscope meets specifications, the oscilloscope must first meet the following conditions:

- The oscilloscope must have been operating continuously for twenty minutes within the specified operating temperature.
- You must perform the Do Self Cal operation, accessible through the Utility menu, if the operating temperature changes by more than 5 °C (9 °F).
- The oscilloscope must be within the factory calibration interval.

All specifications are guaranteed unless noted “typical.”

## Oscilloscope Specifications

**Table 1: Acquisition Specifications**

Characteristic	Description
Acquisition Modes	Sample, Peak Detect, and Average

**Table 2: Input Specifications**

Characteristic	Description
Input Coupling	DC, AC, or Ground AC coupling connects a capacitor in series with the input circuitry. The DC input impedance becomes very high, since capacitance is in series with all paths to ground. Ground coupling mode provides a reference waveform derived from the values identified during SPC. This reference waveform shows visually where ground is expected to be.
Input Impedance, DC Coupled	1 MΩ ±2% in parallel with 20 pF ±3 pF
Probe Scale Factors	1X, 10X, 20X, 50X, 100X, 500X, 1000X voltage attenuation 5, 1, 500 m, 200 m, 100 m 20 m, 10 m, 1 , V/A current scale factor This adjusts the display scale factor of the instrument to accommodate various probe types. Accuracy of the probe used must be added to the accuracy specifications of the instrument. No automatic probe interface is provided, so the user must assure the settings match the probe characteristics. The probe check function allows setting of the proper attenuation for voltage probes.

**Table 2: Input Specifications (cont.)**

Characteristic	Description								
Maximum Input Voltage	At front panel connector, 300 V RMS, Installation Category II; derate at 20 dB/decade above 100 kHz to 13 V peak AC at 3 MHz and above. Based upon sinusoidal or DC input signal. Maximum viewable signal while DC coupled is $\pm 50$ V offset $\pm 5$ V/division at 4 divisions, or 70 V. AC coupling allows measuring signals on a DC level up to 300 V. For non-sinusoidal waveforms, peak value must be less than 450 V. Excursion above 300 V should be less than 100 ms duration and the duty factor is limited to < 44%. RMS signal level must be limited to 300 V. If these values are exceeded, damage to the instrument may result.								
Common Mode Rejection Ratio (CMRR), typical	With the same signal applied to each channel, CMRR is the ratio of the acquired signal amplitude to the amplitude of the MATH difference waveform, either (Ch1 - Ch2), (Ch2 - Ch1), (Ch3 - Ch4) or (Ch4 - Ch3). TDS1012C-EDU, TDS2012C, TDS2014C, TDS2022C, TDS2024C: 100:1 at 60 Hz, reducing to 10:1 with 50 MHz sine wave, with equal Volts/division and Coupling settings on each channel. TDS1001C-EDU, TDS1002C-EDU, TDS2001C, TDS2002C, TDS2004C: 100:1 at 60 Hz, reducing to 20:1 with a sine wave with frequency equal to $\frac{1}{2}$ the -3 dB bandwidth and with equal Volts/division and Coupling settings on each channel.								
Crosstalk (Channel Isolation)	The ratio of the level of a signal input into one channel to that of the same signal present in another channel due to stray coupling.								
	<table border="1"> <thead> <tr> <th><i>TDS1001C-EDU, TDS2001C</i></th> <th><i>TDS1002C-EDU, TDS2002C, 2004C</i></th> <th><i>TDS1012C-EDU, TDS2012C, 2014C</i></th> <th><i>TDS2022C, 2024C</i></th> </tr> </thead> <tbody> <tr> <td>&gt;100:1 with 20 MHz sine wave and with equal V/div settings on each channel</td> <td>&gt;100:1 with 30 MHz sine wave and with equal V/div settings on each channel</td> <td>&gt;100:1 with 50 MHz sine wave and with equal V/div settings on each channel</td> <td>&gt;100:1 with 100 MHz sine wave and with equal V/div settings on each channel</td> </tr> </tbody> </table>	<i>TDS1001C-EDU, TDS2001C</i>	<i>TDS1002C-EDU, TDS2002C, 2004C</i>	<i>TDS1012C-EDU, TDS2012C, 2014C</i>	<i>TDS2022C, 2024C</i>	>100:1 with 20 MHz sine wave and with equal V/div settings on each channel	>100:1 with 30 MHz sine wave and with equal V/div settings on each channel	>100:1 with 50 MHz sine wave and with equal V/div settings on each channel	>100:1 with 100 MHz sine wave and with equal V/div settings on each channel
<i>TDS1001C-EDU, TDS2001C</i>	<i>TDS1002C-EDU, TDS2002C, 2004C</i>	<i>TDS1012C-EDU, TDS2012C, 2014C</i>	<i>TDS2022C, 2024C</i>						
>100:1 with 20 MHz sine wave and with equal V/div settings on each channel	>100:1 with 30 MHz sine wave and with equal V/div settings on each channel	>100:1 with 50 MHz sine wave and with equal V/div settings on each channel	>100:1 with 100 MHz sine wave and with equal V/div settings on each channel						

**Table 3: Vertical Specifications**

Characteristic	Description						
Number of Digitized Bits	8 bits except at 2 mV/div The number of bits in each binary word that results from the A/D converting each analog value value to a digitized value. (IEEE standard 1057, Section 2.2.1) Displayed vertically with 25 digitalization levels per division, 10 divisions dynamic range. 2 mV/division setting is generated by digital multiplication and the resolution is reduced. Given 100 levels available, the resolution is >6.5 bits.						
Sensitivity Range	2 mV/Div to 5 V/Div in 1-2-5 sequence with probe attenuation set to 1X						
Vertical Position Ranges	The position ranges are as follows						
	<table border="1"> <thead> <tr> <th><i>Volts/Div Setting</i></th> <th><i>Position Range</i></th> </tr> </thead> <tbody> <tr> <td>2 mV/div to 200 mV/div</td> <td><math>\pm 1.8</math> V</td> </tr> <tr> <td>&gt;200 mV/div to 5 V/div</td> <td><math>\pm 45</math> V</td> </tr> </tbody> </table>	<i>Volts/Div Setting</i>	<i>Position Range</i>	2 mV/div to 200 mV/div	$\pm 1.8$ V	>200 mV/div to 5 V/div	$\pm 45$ V
<i>Volts/Div Setting</i>	<i>Position Range</i>						
2 mV/div to 200 mV/div	$\pm 1.8$ V						
>200 mV/div to 5 V/div	$\pm 45$ V						

Table 3: Vertical Specifications (cont.)

Characteristic	Description								
Analog Bandwidth, DC Coupled, Sample or Average	V/div values are accurate for probe attenuation settings of 1X. No probe should be installed for these measurements.								
	<table border="1"> <thead> <tr> <th><i>TDS2001C</i></th> <th><i>TDS2002C, 2004C</i></th> <th><i>TDS1012C-EDU, TDS2012C, 2014C</i></th> <th><i>TDS2022C, 2024C</i></th> </tr> </thead> <tbody> <tr> <td>DC to &gt;50 MHz for 5 mV/div through 5 V/div settings with bandwidth limit at full. &lt;5 mV/div settings are limited to 20 MHz BW</td> <td>DC to &gt;70 MHz for 5 mV/div through 5 V/div settings with bandwidth limit at full. &lt;5 mV/div settings are limited to 20 MHz BW</td> <td>DC to &gt;100 MHz for 5 mV/div through 5 V/div settings with bandwidth limit at full. &lt;5 mV/div settings are limited to 20 MHz BW</td> <td>DC to &gt;200 MHz for 5 mV/div through 5 V/div settings with bandwidth limit at full with temperature between 0 and 35 °C.  DC to &gt;160 MHz from 5 mV/div through 5 V/div settings with bandwidth limit at full for temperatures between 0 and 50 °C. &lt; 5mV/div settings are limited to 20 MHz BW</td> </tr> </tbody> </table>	<i>TDS2001C</i>	<i>TDS2002C, 2004C</i>	<i>TDS1012C-EDU, TDS2012C, 2014C</i>	<i>TDS2022C, 2024C</i>	DC to >50 MHz for 5 mV/div through 5 V/div settings with bandwidth limit at full. <5 mV/div settings are limited to 20 MHz BW	DC to >70 MHz for 5 mV/div through 5 V/div settings with bandwidth limit at full. <5 mV/div settings are limited to 20 MHz BW	DC to >100 MHz for 5 mV/div through 5 V/div settings with bandwidth limit at full. <5 mV/div settings are limited to 20 MHz BW	DC to >200 MHz for 5 mV/div through 5 V/div settings with bandwidth limit at full with temperature between 0 and 35 °C.  DC to >160 MHz from 5 mV/div through 5 V/div settings with bandwidth limit at full for temperatures between 0 and 50 °C. < 5mV/div settings are limited to 20 MHz BW
	<i>TDS2001C</i>	<i>TDS2002C, 2004C</i>	<i>TDS1012C-EDU, TDS2012C, 2014C</i>	<i>TDS2022C, 2024C</i>					
	DC to >50 MHz for 5 mV/div through 5 V/div settings with bandwidth limit at full. <5 mV/div settings are limited to 20 MHz BW	DC to >70 MHz for 5 mV/div through 5 V/div settings with bandwidth limit at full. <5 mV/div settings are limited to 20 MHz BW	DC to >100 MHz for 5 mV/div through 5 V/div settings with bandwidth limit at full. <5 mV/div settings are limited to 20 MHz BW	DC to >200 MHz for 5 mV/div through 5 V/div settings with bandwidth limit at full with temperature between 0 and 35 °C.  DC to >160 MHz from 5 mV/div through 5 V/div settings with bandwidth limit at full for temperatures between 0 and 50 °C. < 5mV/div settings are limited to 20 MHz BW					
<table border="1"> <thead> <tr> <th><i>TDS1001C-EDU</i></th> <th><i>TDS1002C-EDU</i></th> </tr> </thead> <tbody> <tr> <td>DC to &gt;40 MHz for 5 mV/div through 5 V/div settings with bandwidth limit at full. &lt;5 mV/div settings are limited to 20 MHz BW.</td> <td>DC to &gt;60 MHz for 5 mV/div through 5 V/div settings with bandwidth limit at full. &lt;5 mV/div settings are limited to 20 MHz BW</td> </tr> </tbody> </table>	<i>TDS1001C-EDU</i>	<i>TDS1002C-EDU</i>	DC to >40 MHz for 5 mV/div through 5 V/div settings with bandwidth limit at full. <5 mV/div settings are limited to 20 MHz BW.	DC to >60 MHz for 5 mV/div through 5 V/div settings with bandwidth limit at full. <5 mV/div settings are limited to 20 MHz BW					
<i>TDS1001C-EDU</i>	<i>TDS1002C-EDU</i>								
DC to >40 MHz for 5 mV/div through 5 V/div settings with bandwidth limit at full. <5 mV/div settings are limited to 20 MHz BW.	DC to >60 MHz for 5 mV/div through 5 V/div settings with bandwidth limit at full. <5 mV/div settings are limited to 20 MHz BW								
Analog Bandwidth, DC Coupled, Peak Detect	The Analog Bandwidth when the instrument is DC coupled. V/div values are accurate for probe attenuation settings of 1X. No probe should be installed for these measurements.								
	<table border="1"> <thead> <tr> <th><i>TDS1001C-EDU, TDS2001C</i></th> <th><i>TDS1002C-EDU, TDS2002C, 2004C</i></th> <th><i>TDS1012C-EDU, TDS2012C, 2014C, 2022C, 2024C</i></th> </tr> </thead> <tbody> <tr> <td>DC to &gt;30 MHz for 5 mV/div through 5 V/div settings with bandwidth limit at full. Setting less than 5 mV/div are limited to 20 MHz BW</td> <td>DC to &gt;50 MHz for 5 mV/div through 5 V/div settings with bandwidth limit at full. Setting less than 5 mV/div are limited to 20 MHz BW</td> <td>DC to &gt;75 MHz for 5 mV/div through 5 V/div settings with bandwidth limit at full. Setting less than 5 mV/div are limited to 20 MHz BW</td> </tr> </tbody> </table>	<i>TDS1001C-EDU, TDS2001C</i>	<i>TDS1002C-EDU, TDS2002C, 2004C</i>	<i>TDS1012C-EDU, TDS2012C, 2014C, 2022C, 2024C</i>	DC to >30 MHz for 5 mV/div through 5 V/div settings with bandwidth limit at full. Setting less than 5 mV/div are limited to 20 MHz BW	DC to >50 MHz for 5 mV/div through 5 V/div settings with bandwidth limit at full. Setting less than 5 mV/div are limited to 20 MHz BW	DC to >75 MHz for 5 mV/div through 5 V/div settings with bandwidth limit at full. Setting less than 5 mV/div are limited to 20 MHz BW		
<i>TDS1001C-EDU, TDS2001C</i>	<i>TDS1002C-EDU, TDS2002C, 2004C</i>	<i>TDS1012C-EDU, TDS2012C, 2014C, 2022C, 2024C</i>							
DC to >30 MHz for 5 mV/div through 5 V/div settings with bandwidth limit at full. Setting less than 5 mV/div are limited to 20 MHz BW	DC to >50 MHz for 5 mV/div through 5 V/div settings with bandwidth limit at full. Setting less than 5 mV/div are limited to 20 MHz BW	DC to >75 MHz for 5 mV/div through 5 V/div settings with bandwidth limit at full. Setting less than 5 mV/div are limited to 20 MHz BW							
Analog Bandwidth Selections	20 MHz BW Limit ON/OFF								
Lower Frequency Limit, AC Coupled	<p>≤ 10 Hz</p> <p>≤ 1 Hz when 10X passive probes are used.</p>								
Rise Time, typical	Rise time is generally calculated from the following formula: Rise time in ns = 350 / Bandwidth in MHz								
	<table border="1"> <thead> <tr> <th><i>TDS2001C</i></th> <th><i>TDS2002C, 2004C</i></th> <th><i>TDS1012C-EDU, TDS2012C, 2014C</i></th> <th><i>TDS2022C, 2024C</i></th> </tr> </thead> <tbody> <tr> <td>= 7.0 ns</td> <td>= 5.0 ns</td> <td>= 3.5 ns</td> <td>= 2.1 ns</td> </tr> </tbody> </table>	<i>TDS2001C</i>	<i>TDS2002C, 2004C</i>	<i>TDS1012C-EDU, TDS2012C, 2014C</i>	<i>TDS2022C, 2024C</i>	= 7.0 ns	= 5.0 ns	= 3.5 ns	= 2.1 ns
	<i>TDS2001C</i>	<i>TDS2002C, 2004C</i>	<i>TDS1012C-EDU, TDS2012C, 2014C</i>	<i>TDS2022C, 2024C</i>					
	= 7.0 ns	= 5.0 ns	= 3.5 ns	= 2.1 ns					
<table border="1"> <thead> <tr> <th><i>TDS1001C-EDU</i></th> <th><i>TDS1002C-EDU</i></th> </tr> </thead> <tbody> <tr> <td>= 8.8 ns</td> <td>= 5.8 ns</td> </tr> </tbody> </table>	<i>TDS1001C-EDU</i>	<i>TDS1002C-EDU</i>	= 8.8 ns	= 5.8 ns					
<i>TDS1001C-EDU</i>	<i>TDS1002C-EDU</i>								
= 8.8 ns	= 5.8 ns								
Peak Detect Mode Pulse Response	The capability of the instrument to capture single event pulses using Peak Detect Acquisition Mode.								
	The minimum single pulse widths for guaranteed 50% or greater amplitude capture are as follows:								
	<table border="1"> <thead> <tr> <th><i>Sec/Div Setting</i></th> <th><i>Minimum Pulse Width</i></th> </tr> </thead> <tbody> <tr> <td>50 s/div to 5 us/div</td> <td></td> </tr> <tr> <td><i>TDS1002C-EDU, TDS1012C-EDU, TDS2002C, TDS2004C, TDS2012C, TDS2014C, TDS2022C, TDS2024C, TDS2001C</i></td> <td>12 ns</td> </tr> <tr> <td><i>TDS1001C-EDU, TDS2001C</i></td> <td>13 ns</td> </tr> </tbody> </table>	<i>Sec/Div Setting</i>	<i>Minimum Pulse Width</i>	50 s/div to 5 us/div		<i>TDS1002C-EDU, TDS1012C-EDU, TDS2002C, TDS2004C, TDS2012C, TDS2014C, TDS2022C, TDS2024C, TDS2001C</i>	12 ns	<i>TDS1001C-EDU, TDS2001C</i>	13 ns
	<i>Sec/Div Setting</i>	<i>Minimum Pulse Width</i>							
50 s/div to 5 us/div									
<i>TDS1002C-EDU, TDS1012C-EDU, TDS2002C, TDS2004C, TDS2012C, TDS2014C, TDS2022C, TDS2024C, TDS2001C</i>	12 ns								
<i>TDS1001C-EDU, TDS2001C</i>	13 ns								
DC Gain Accuracy, Sample or Average Acquisition	±3%, 5 V/div through 10 mV/div.								
	±4%, 5 mV/div and 2 mV/div.								

**Table 3: Vertical Specifications (cont.)**

Characteristic	Description	
DC Voltage Measurement Accuracy, Average Acquisition Mode	The accuracy of DC voltage measurements acquired using Average of $\geq 16$ waveforms.	
	Vertical Position = 0	$\pm(3\% \text{ of }  \text{reading}  + 0.1 \text{ div} + 1 \text{ mV})$ .
	Vertical Position $\neq 0$ and Vertical Scale 2 mV/div to 200 mV/div:	$\pm[3\% \text{ of } ( \text{reading} + \text{vertical position} ) + 1\% \text{ of }  \text{vertical position}  + 0.2 \text{ div} + 7 \text{ mV}]$
	Vertical Position $\neq 0$ , and Vertical Scale $>200 \text{ mV/div}$	$\pm[3\% \text{ of } ( \text{reading} + \text{vertical position} ) + 1\% \text{ of }  \text{vertical position}  + 0.2 \text{ div} + 175 \text{ mV}]$
Delta Volts Measurement Accuracy, Average Acquisition Mode	Delta Volts between any two averages of 16 waveforms acquired under the same setup and ambient conditions (3% of  reading  + 0.05 div)	
Vertical Position Accuracy	Volts/Division Setting	Position Accuracy
	2 mV/div to 200 mV/div	$\pm((1\% *  \text{selected value} ) + 0.1 \text{ div} + 5 \text{ mV})$ within the range $\pm 1.8 \text{ V}$
	$> 200 \text{ mV/div}$ to 5 V/div	$\pm((1\% *  \text{selected value} ) + 0.1 \text{ div} + 125 \text{ mV})$ within the range $\pm 45 \text{ V}$

**Table 4: Horizontal Specifications**

Characteristic	Description	
Sample Rate Range	<i>TDS1001C-EDU, TDS1002C-EDU, TDS1012C-EDU, TDS2001C, 2002C, 2004C</i>	
	5 S/s to 1 GS/s	5 S/s to 2 GS/s
Waveform Interpolation	(sin x)/x Waveform interpolation is activated for sweep speeds of 100 ms/div and faster.	
Record Length	2500 samples per record	
Seconds/Division Range	<i>TDS1001C-EDU, TDS1002C-EDU, TDS1012C-EDU, TDS2001C, 2002C, 2004C</i>	
	5 ns/div to 50 s/div, in a 1, 2.5, 5 sequence	2.5 ns/div to 50 s/div in 1, 2.5, 5 sequence
Long Term Sample Rate and Horizontal Position Time Accuracy	$\pm 50$ parts per million over any $\geq 1 \text{ ms}$ time interval	
Delta Time Measurement Accuracy (Full Bandwidth)	The limits are given in the following table for signals having amplitude $\geq 5$ divisions, slew rate at the measurement points of $\geq 2.0$ divisions/ns, and acquired $\geq 10 \text{ mV/Div}$ :	
	<i>Condition</i>	<i>Time Measurement Accuracy</i>
	Single-shot, Sample mode	$\pm(1 \text{ sample interval} + 100 \text{ parts per million} *  \text{reading}  + 0.6 \text{ ns})$
	$> 16$ averages	$\pm(1 \text{ sample interval} + 100 \text{ parts per million} *  \text{reading}  + 0.4 \text{ ns})$
Horizontal Position Time Range	5 ns/div to 10 ns/div	(-4 div $\times$ s/div) to 20 ms
	25 ns/div to 100 $\mu\text{s/div}$	(-4 div $\times$ s/div) to 50 ms
	250 $\mu\text{s/div}$ to 10 s/div	(-4 div $\times$ s/div) to 50 s
	2.5 s/div to 50 s/div	(-4 div $\times$ s/div) to 250 s
	The user controls the time from the trigger to the center graticule on the display with the Horizontal Position knob The resolution of the horizontal position time is 1/25 of a horizontal division.	

Table 5: Trigger Specifications

Characteristic	Description			
Sensitivity, Edge-Type Trigger, DC Coupled	Trigger Source		Sensitivity (Measurement style A)	Sensitivity (Measurement style B)
	Channel Inputs	All Products	1.5 div from DC to 10 MHz (>2 mV/div) 4 div from DC to 10 MHz (2 mV/div)	1 div from DC to 10 MHz (>2 mV/div) 2.5 div from DC to 10 MHz (2 mV/div)
		TDS1001C-EDU	3 div between 10 MHz and 40 MHz	1.5 div between 10 MHz and 40 MHz
		TDS1002C-EDU	3 div between 10 MHz and 60 MHz	1.5 div between 10 MHz and 60 MHz
		TDS2001C	3 div between 10 MHz and 50 MHz	1.5 div between 10 MHz and 50 MHz
		TDS2002C, TDS2004C	3 div between 10 MHz and 70 MHz	1.5 div between 10 MHz and 70 MHz
		TDS1012C-EDU, TDS2012C, TDS2014C	3 div between 10 MHz and 100 MHz	1.5 div between 10 MHz and 100 MHz
		TDS2022C, TDS2024C	3 div between 10 MHz and 200 MHz	1.5 div from 10 MHz to 100 MHz 2.0 div above 100 MHz to 200 MHz
	EXT		300 mV from DC to 100 MHz 500 mV from 100 MHz to 200 MHz (TDS2022C and TDS2024C)	200 mV from DC to 100 MHz 350 mV from 100 MHz to 200 MHz (TDS2022C and TDS2024C)
		EXT/5	1.5 V from DC to 100 MHz 2.5 V from 100 MHz to 200 MHz (TDS2022C and TDS2024C)	1 V from DC to 100 MHz 1.75 V from 100 MHz to 200 MHz (TDS2022C and TDS2024C)
Sensitivity, Edge-Type Trigger, non-DC Coupled, typical	The typical sensitivities are as follows:			
	Trigger Source	Sensitivity		
	AC	Same as DC Coupled limits for frequencies 50 Hz and above		
	NOISE REJ	Effective in Sample or Average Mode, >10 mV/div to 5 V/div. Reduces DC Coupled trigger sensitivity by 2X.		
	HF REJ	Same as DC Coupled limits from DC to 7 KHz.		
LF REJ	Same as DC Coupled limits for frequencies above 300 KHz.			
Trigger Level Ranges, typical	The settable resolution for the trigger level is 0.02 division for an input channel source, 4 mV for an Ext source, and 20 mV for an Ext/5 source.			
	Input channels	±8 divisions from center screen		
	EXT	± 1.6 V		
	EXT/5	± 8 V		
Trigger Level Accuracy, DC Coupled, typical	±(0.2 div +5 mV) for signals within ±4 divisions from center screen, having rise and fall times of >20 ns			
	EXT	±(6% of setting + 40 mV) for signals less than ±800 mV		
	EXT/5	±(6% of setting + 200 mV) for signals less than ±4 V		
Lowest Frequency for Successful Operation of "Set Level to 50%" Function, typical	50 Hz.			
Default Settings for Video Trigger	Trigger Mode	Auto		
	Trigger Coupling	AC		

**Table 5: Trigger Specifications (cont.)**

Characteristic	Description	
Video Trigger Sensitivity, typical	A 2 division composite video signal will have a 0.6 division sync tip.	
	The typical sensitivities are as follows:	
	<i>Source</i>	<i>Typical Sensitivity</i>
	Input Channels	2 divisions of composite video
	EXT	400 mV of composite video
	EXT/5	2 V of composite video
Video Trigger Formats and Field Rates	Field rates:	50 Hz to 60 Hz
	Line rates:	15 kHz to 20 kHz (NTSC, PAL, SECAM)
Trigger Hold Off Range	500 ns minimum to 10 s maximum	
Pulse Width Trigger Modes	< (Less than), > (Greater than), = (Equal), ≠ (Not Equal)	
Pulse Width Trigger Point	Equal: The oscilloscope triggers when the trailing edge of the pulse crosses the trigger level.	
	Not Equal: If the pulse is narrower than the specified width, the trigger point is the trailing edge. Otherwise, the oscilloscope triggers when a pulse continues longer than the time specified as the Pulse Width.	
	Less than: The trigger point is the trailing edge.	
	Greater than (also called time-out trigger): The oscilloscope triggers when a pulse continues longer than the time specified as the Pulse Width.	
Pulse Width Range	33 ns ≤ width ≤ 10 sec	
Pulse Width Resolution	16.5 ns or 1 part per thousand, whichever is larger	
Equal Guardband	t > 330 ns: ±5% ≤ guardband < ±(5.1% + 16.5 ns)	
	t ≤ 330 ns: guardband = ±16.5 ns	
	All pulses, even from the most stable sources, have some amount of jitter. To avoid disqualifying pulses that are intended to qualify but are not absolutely correct values, we provide an arbitrary guardband. Any measured pulse width within the guardband will qualify. If looking for pulse width differences that are smaller than the guardband width, offsetting the center should allow discriminating differences down to the guardband accuracy.	
Not Equal Guardband	t > 330 ns: ±5% ≤ guardband < ±(5.1% + 16.5 ns)	
	165 ns < t ≤ 330 ns: guardband = -16.5 ns/+33 ns	
	t ≤ 165 ns: guardband = ±16.5 ns	
	All pulses, even from the most stable sources, have some amount of jitter. To avoid disqualifying pulses that are intended to qualify but are not absolutely correct values, we provide an arbitrary guardband. Any measured pulse width outside the guardband will qualify. If looking for pulse width differences that are smaller than the guardband width, offsetting the center should allow discriminating differences down to the guardband accuracy. Not equal has slightly better ability to deal with small pulse widths than equal. The accuracy is not better.	

**Trigger Frequency Counter**

Frequency Counter Resolution	6 digits
Frequency Counter Accuracy (typical)	±51 parts per million including all frequency reference errors and ±1 count errors
Frequency Counter Frequency Range	AC coupled, 10 Hz minimum to rated bandwidth
Frequency Counter Signal Source	Pulse width or edge selected trigger source
	Frequency counter measures selected trigger source at all times in pulse width and edge mode, including when oscilloscope acquisition is halted due to changes in run status, or acquisition of a single shot event has completed.
	The frequency counter does not measure pulses that do not qualify as legitimate trigger events.
	Pulse Width mode: Counts pulses of sufficient magnitude inside the 250 ms measurement window that qualify as triggerable events (e.g. all narrow pulses in a PWM pulse train if set to < mode and the limit is set to a relatively small number).
	Edge Trigger mode: Counts all pulses of sufficient magnitude.



**Table 6: General Specifications**

Characteristic	Description	
<b>Display</b>		
Display Type	11.5 cm (W) x 8.64 cm (H), 14.38 cm diagonal, ¼ VGA, active TFT color liquid crystal display (LCD) with color characters/waveforms on a black background. Surface anti-glare (3H) treatment	
Display Resolution	320 horizontal by 240 vertical pixels The video display comprises both the character and waveform displays.	
Brightness, typical	400 cd/ m <sup>2</sup> typical, 320 cd/m <sup>2</sup> min.	
<b>Probe Compensator Output</b>		
Probe Compensator, Output Voltage and Frequency, typical	Characteristics are as follows: Output voltage 5.0 V ±10% into 1 Meg Ω load Frequency 1 kHz	
<b>Power Source</b>		
Source Voltage	Full Range: 100 to 240 VAC RMS ±10%, Installation Category II (Covers range of 90 to 264 VAC)	
Power Consumption	Less than 30 W at 85 to 275 VAC input.	
<b>Environmental</b>		
Temperature	Operating	0° C to +50° C, with 5° C/minute maximum gradient, non-condensing, up to 3000m altitude
	Nonoperating	-40° C to +71° C, with 5° C/minute maximum gradient
Cooling Method	Convection cooled	
Humidity: Operating and Non-Operating	Operating:	5% to 85% relative humidity (% RH) at up to +40° C 5% to 45% RH above +40° C up to +50° C, non-condensing, and as limited by a Maximum Wet-Bulb Temperature of +37° C (derates relative humidity to 45 % RH at +50° C)
	Non-Operating:	5% to 85% RH (Relative Humidity) at up to +40° C, 5% to 45% RH above +40° C up to +50° C, non-condensing. Above +50° C limited by a Maximum Wet-Bulb Temperature of +37° C (derates relative humidity to 12% RH at +71° C)
Altitude: Operating and Non-Operating	Operating:	Up to 3000 meters (10,000 feet)
	Non-Operating:	Up to 3000 meters (10,000 feet). Altitude is limited by possible damage to LCD at higher altitudes. This damage is independent of operation
<b>Mechanical</b>		
Overall Dimensions	Requirements that follow are nominal:	
	Height	158.0 mm (6.22 in.)
	Width	326.3 mm (12.85 in)
	Depth	124.1 mm (4.88 in)
Weight	Requirements that follow are nominal:	
	Stand alone instrument	2.0 kg (4.4 lbs)
	With accessories	2.2 kg (4.9 lbs)
	When packaged for domestic shipment	3.6 kg (8 lbs)



# Appendix B: TPP0101 and TPP0201 Series 10X Passive Probes Information

The TPP0101 & TPP0201 Series 10X Passive Probes are high impedance, passive probes with 10X attenuation that are designed for use with the following Tektronix oscilloscopes:

- TDS1000C-EDU/TDS2000C oscilloscopes that have 20 pF of input capacitance. The compensation range of these probes is 15–25 pF.

The probes have no user- or Tektronix-serviceable parts.



**WARNING.** Do not float the TPP0101 and TPP0201 probes on any oscilloscope.

## Connecting the Probe to the Oscilloscope

Connect the probe as shown in the illustrations below.

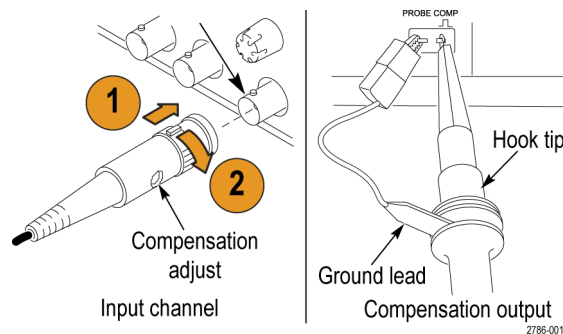

## Compensating the Probe

Due to variations in oscilloscope input characteristics, the low-frequency compensation of the probe may need adjustment after moving the probe from one oscilloscope channel to another.

If a 1 kHz calibrated square wave displayed at 1 ms/division shows significant differences between the leading and trailing edges, perform the following steps to optimize low-frequency compensation:

1. Connect the probe to the oscilloscope channel that you plan to use for your measurements.
2. Connect the probe to the probe compensation output terminals on the oscilloscope front panel.



**WARNING.** To avoid electric shock, only connect to the Probe Comp signal on the oscilloscope when making this adjustment.

---

3. Push **Autoset** or otherwise adjust your oscilloscope to display a stable waveform.
4. Adjust the trimmer in the probe until you see a perfectly flat-top square wave on the display. (See illustration.)



**WARNING.** To avoid electric shock, only use the insulated adjustment tool when making compensation adjustments.

---

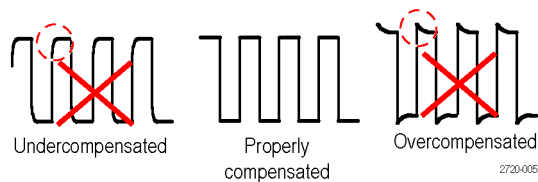

## Connecting the Probe to the Circuit

Use the standard accessories included with the probe to connect to your circuit.





**WARNING.** To avoid electric shock when using the probe or accessories, keep fingers behind the finger guard of the probe body and accessories.

To reduce risk of shock, ensure the ground lead and ground spring are fully mated before connecting the probe to the circuit under test.

---

## Standard Accessories

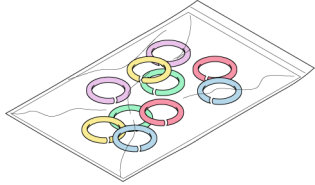
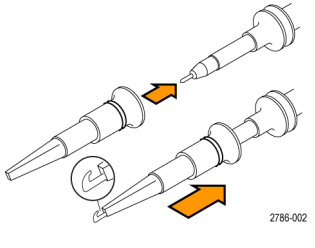
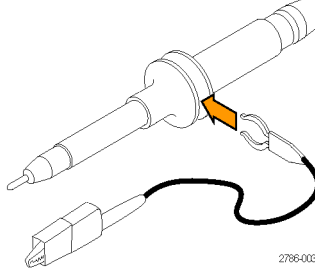
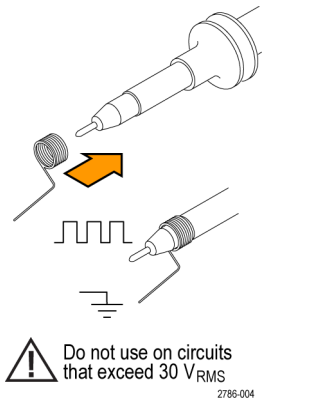
The accessories included with the probe are shown below.

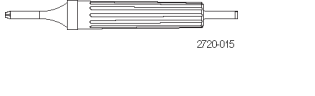
Item	Description
	<p><b>Color bands</b></p> <p>Use these bands to identify the oscilloscope channel at the probe head.</p> <p>Reorder Tektronix part number 016-0633-xx (5 pairs)</p>
 <p style="text-align: right; font-size: small;">2786-002</p>	<p><b>Hook tip</b></p> <p>Press the hook tip onto probe tip and then clamp the hook onto the circuit.</p> <p>Reorder Tektronix part number 013-0362-xx</p>
 <p style="text-align: right; font-size: small;">2786-003</p>	<p><b>Ground lead, with alligator clip</b></p> <p>Secure the lead to the probe head ground and then to your circuit ground.</p> <p>Reorder Tektronix part number 196-3521-xx</p>
 <p style="text-align: right; font-size: small;">2786-004</p> <p> Do not use on circuits that exceed 30 V<sub>RMS</sub></p>	<p><b>Ground spring</b></p> <p>The ground spring minimizes aberrations on high-frequency signals caused by the inductance of the ground path, giving you measurements with good signal fidelity.</p> <p>Attach the spring to the ground band on the probe tip. You can bend the spring out to ~0.75 in. away from the signal test point.</p> <p>Reorder Tektronix part number 016-2028-xx (2 ea.)</p>
 <p style="text-align: right; font-size: small;">2720-015</p>	<p><b>Adjustment tool</b></p> <p>Reorder Tektronix part number 003-1433-xx</p>

## Optional Accessories

You can order the following accessories for your probe.

Accessory	Part number
Alligator Ground Lead, 12 in	196-3512-xx
6" Clip-on Ground Lead	196-3198-xx
Ground Spring, Short, 2 ea.	016-2034-xx
MicroCKT Test Tip	206-0569-xx
Micro Hook Tip	013-0363-xx
Universal IC Cap	013-0366-xx
Circuit Board Test Point/PCB Adapter	016-2016-xx
Wire, spool, 32 AWG	020-3045-xx

## Specifications

**Table 7: Electrical and mechanical specifications**

Characteristic	TPP0101	TPP0201
Bandwidth (-3 dB)	DC to 100 MHz	DC to 200 MHz
System attenuation accuracy	10:1 $\pm$ 3.2%	10:1 $\pm$ 3.2%
Compensation range	TPP0101: 15 pF – 25 pF	TPP0201: 15 pF – 25 pF
System input resistance @ DC	10 M $\Omega$ $\pm$ 1.5%	10 M $\Omega$ $\pm$ 1.5%
System input capacitance	<12 pF	<12 pF
System rise time (typical)	<3.5 ns	<2.3 ns
Propagation delay	~6.1 ns	~6.1 ns
Maximum input voltage	300 V <sub>RMS</sub> CAT II	300 V <sub>RMS</sub> CAT II
Cable length	1.3 m	1.3 m

**Table 8: Environmental specifications**

Characteristics	Description
Temperature	
Operating	-10 °C to +55 °C (14 °F to +131 °F)
Nonoperating	-51 °C to +71 °C (-60 °F to +160 °F)
Humidity	
Operating and Non-Operating	5% to 95% relative humidity (%RH) up to +30 °C (86 °F), 5% to 65% RH above +30 °C up to +55 °C (131 °F)
Altitude	
Operating	3.0 km (10,000 ft) maximum
Nonoperating	12.2 km (40,000 ft) maximum

## Performance Graphs

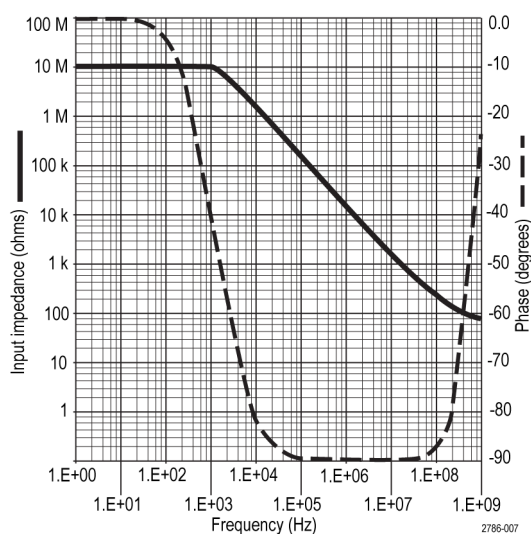
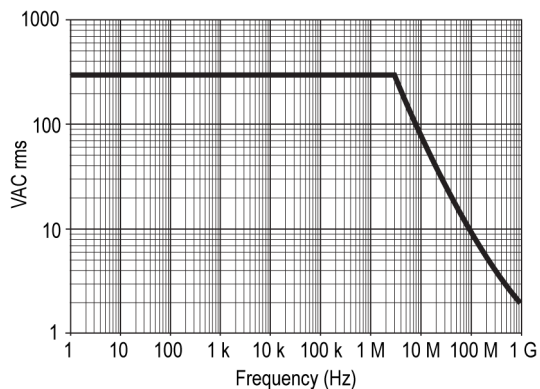

**Table 9: Certifications and compliances**

Characteristics	Description
EC Declaration of Conformity	Compliance was demonstrated to the following specification as listed in the Official Journal of the European Communities: Low Voltage Directive 2006/95/EC: EN61010-031: 2002
Safety Standards	UL61010-031:2007 CAN/CSA C22.2 No. 61010-031-07 IEC61010-031; IEC 61010-031/A1:2008

**Table 9: Certifications and compliances (cont.)**

Characteristics	Description	
Measurement Category Descriptions	Category	<i>Examples of Products in this Category</i>
	CAT III	Distribution-level mains, fixed installation
	CAT II	Local-level mains, appliances, portable equipment
	CAT I	Circuits not directly connected to mains.
Pollution Degree 2	Do not operate in environments where cond- uctive pollutants may be present (as defined in IEC 61010-1). Rated for indoor use only.	



**Equipment Recycling.** This product complies with the European Union's requirements according to Directive 2002/96/EC on waste electrical and electronic equipment (WEEE). For more information about recycling options, check the Support/Service section of the Tektronix Web site ([www.tektronix.com](http://www.tektronix.com)).

## Safety Summary

Review the following safety precautions to avoid injury and prevent damage to this product or any products connected to it. To avoid potential hazards, use this product only as specified. Using the probe or accessories in a manner not specified could result in a shock or fire hazard.

### To Avoid Fire or Personal Injury

**Ground-Referenced Oscilloscope Use.** Do not float the reference lead of this probe when using with ground referenced oscilloscopes (for example, TDS series oscilloscopes). The reference lead must be connected to earth potential (0 V).

**Connect and Disconnect Properly.** Connect the probe output to the measurement instrument before connecting the probe to the circuit under test. Disconnect the probe input and the probe reference lead from the circuit under test before disconnecting the probe from the measurement instrument.

**Avoid Electric Shock.** Do not connect or disconnect probes or test leads while they are connected to a voltage source.

**Observe All Terminal Ratings.** To avoid fire or shock hazard, observe all ratings and markings on the product. Consult the product manual for further ratings information before making connections to the product.

**Avoid Electric Shock.** When using probe accessories, never exceed the lowest rating of the probe or its accessory, whichever is less, including the measurement category and voltage rating.

**Inspect the Probe and Accessories.** Before each use, inspect the probe and accessories for damage (cuts, tears, defects in the probe body, accessories, cable jacket, etc.). Do not use if damaged.



**Do Not Operate in Wet/Damp Conditions.**

**Do Not Operate in an Explosive Atmosphere.**

**Keep Product Surfaces Clean and Dry.**

**Safety Terms and Symbols  
Terms in This Manual.**

These terms may appear in this manual:



**WARNING.** *Warning statements identify conditions or practices that could result in injury or loss of life.*

---



**CAUTION.** *Caution statements identify conditions or practices that could result in damage to this product or other property.*

---

**Symbols on the Product.** These symbols may appear on the product:



Caution  
Refer to Manual



Earth Terminal



---

## Appendix C: Accessories

All accessories (standard and optional) are available by contacting your local Tektronix field office.

### Standard Accessories

---



**TPP0101 or TPP0201, 10X Passive Voltage Probe.** The TPP0101 probes have a system bandwidth of DC to 100 MHz at -3 dB and ship standard with TDS2000C oscilloscope models that have bandwidths <100 MHz and with all TDS1000C-EDU models.

The TPP0201 probes have a system bandwidth of DC to 200 MHz at -3 dB and ship standard with TDS2000C oscilloscope models that have bandwidths of  $\geq 100$  MHz.

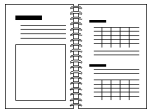

**TDS2000C and TDS1000C-EDU Series Oscilloscope User Manual.** A single user manual is included. Refer to the Optional Accessories for a complete list of available language manuals.

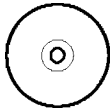

**PC Communications CD-ROM.** The PC Communications software provides easy transfer of data from the oscilloscope to a PC.

### Optional Accessories

---



**P6101B 1X Passive Voltage Probe.** The P6101B probe has a 15 MHz bandwidth with a rating of  $300 V_{\text{RMS}}$  CAT II.

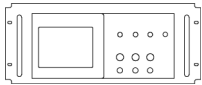

**RM2000B Rackmount Kit.** The RM2000B Rackmount Kit lets you install a TDS2000C series oscilloscope into an industry-standard 19 inch rack. The rackmount kit requires seven inches (18 cm) of vertical rack space. You can turn the oscilloscope power on or off from the front of the rackmount kit. The rackmount kit does not have slide-out capability.

---

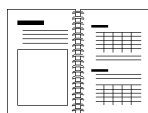

**TDS2000C and TPS2000 Series Digital Oscilloscopes Programmer Manual .**

The programmer manual (077-0444-XX, English) provides command and syntax information.



**TDS2000C Series Digital Storage Oscilloscope Service Manual.**

The service manual (077-0446-XX, English) provides module-level repair information.

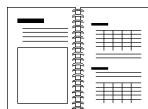

**TDS2000C and TDS1000C-EDU Series Digital Storage Oscilloscope User Manuals.**

The user manual is available in these languages:

- English, 071-2722-XX
- French, 071-2723-XX
- Italian, 071-2724-XX
- German, 071-2725-XX
- Spanish, 071-2726-XX
- Japanese, 071-2727-XX
- Portuguese, 071-2728-XX
- Simplified Chinese, 071-2729-XX
- Traditional Chinese, 071-2730-XX
- Korean, 071-2731-XX
- Russian, 071-2732-XX

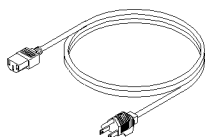

**International Power Cords.** In addition to the power cord shipped with your oscilloscope, you can obtain the following cords:

- Option A0, North American 120 V, 60 Hz, 161-0066-00
- Option A1, European 230 V, 50 Hz, 161-0066-09
- Option A2, United Kingdom 230 V, 50 Hz, 161-0066-10
- Option A3, Australian 240 V, 50 Hz, 161-0066-13
- Option A5, Switzerland 230 V, 50 Hz, 161-0154-00
- Option A6, Japan 100 V, 50/60 Hz, 161-0342-00
- Option A10, China 220 V, 50 Hz, 161-0304-00
- Option A11, India 230 V, 50 Hz, 161-0400-00
- Option A12, Brazil 127/220 V, 60 Hz, 161-0357-00

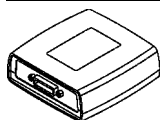

**TEK-USB-488 Adapter.** The GPIB adapter allows you to connect your oscilloscope to a GPIB controller.

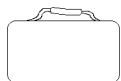

**Soft Case.** The soft case (AC2100) protects the oscilloscope from damage and provides space for probes, a power cord, and manuals.

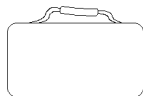

**Transit Case.** The transit case (HCTEK4321) provides shock, vibration, impact and moisture protection for the oscilloscope when you transport it from one place to another. The required soft case fits inside the transit case.

---

# Appendix D: Cleaning

## General Care

Do not store or leave the oscilloscope where the LCD display will be exposed to direct sunlight for long periods of time.



**CAUTION.** *To avoid damage to the oscilloscope or probes, do not expose them to sprays, liquids, or solvents.*

---

## Cleaning

Inspect the oscilloscope and probes as often as operating conditions require. To clean the exterior surface, perform the following steps:

1. Remove loose dust on the outside of the oscilloscope and probes with a lint-free cloth. Use care to avoid scratching the clear glass display filter.
2. Use a soft cloth dampened with water to clean the oscilloscope. Use an aqueous solution of 75% isopropyl alcohol for more efficient cleaning.



**CAUTION.** *To avoid damage to the surface of the oscilloscope or probes, do not use any abrasive or chemical cleaning agents.*

---



# Appendix E: Default Setup

This appendix describes the options, buttons and controls that change settings when you push the **Default Setup** button. The last page of this appendix lists settings that do not change.

---

**NOTE.** When you push the **Default Setup** button, the oscilloscope displays the CH1 waveform and removes all other waveforms.

---

Menu or system	Option, button, or knob	Default setting
ACQUIRE	(three mode options)	Sample
	Averages	16
	Run/Stop	RUN
AUTORANGE	Autorange	Off
	Mode	Vertical and Horizontal
CURSOR	Type	Off
	Source	CH1
	Horizontal (amplitude)	+/- 3.2 divs
	Vertical (time)	+/- 4 divs
DISPLAY	Type	Vectors
	Persist	Off
	Format	YT
HORIZONTAL	Window	Main
	Trig Knob	Level
	Position	0.00 s
	Scale (seconds/division)	500 ms
	Window Zone	50 ms
MATH	Operation	-
	Sources	CH1 - CH2
	Position	0 divs
	Vertical Scale	2 V
	FFT operation:	CH1
	Source	Hanning
	Window	X1
FFT Zoom		
MEASURE (all)	Source	CH1
	Type	None
TRIGGER (common)	Type	Edge
	Source	CH1

Menu or system	Option, button, or knob	Default setting
TRIGGER (Edge)	Slope	Rising
	Mode	Auto
	Coupling	DC
	Level	0.00 V
TRIGGER (Video)	Polarity	Normal
	Sync	All Lines
	Standard	NTSC
TRIGGER (Pulse)	When	=
	Set Pulse Width	1.00 ms
	Polarity	Positive
	Mode	Auto
	Coupling	DC
Vertical system, all channels	Coupling	DC
	BW Limit	Off
	Vertical scale (volts/division)	Coarse
	Probe	Voltage
	Voltage Probe Attenuation	10X
	Current Probe Scale	10 A/V
	Invert	Off
	Position	0.00 divs (0.00 V)
Scale (volts/division)	1.00 V	

The **Default Setup** button does not reset the following settings:

- Language option
- Saved setups
- Saved reference waveforms
- Calibration data
- Printer setup
- GPIB setup
- Probe setup (type and attenuation factor)
- Date and time
- Current folder on the USB flash drive



---

## Appendix F: Font Licenses

The following license agreements cover Asian fonts used in the TDS2000C and TDS1000C-EDU series oscilloscopes.

Copyright © 1988 The Institute of Software, Academia Sinica.

Correspondence Address: P.O.Box 8718, Beijing, China 100080.

Permission to use, copy, modify, and distribute this software and its documentation for any purpose and without fee is hereby granted, provided that the above copyright notices appear in all copies and that both those copyright notices and this permission notice appear in supporting documentation, and that the name of "the Institute of Software, Academia Sinica" not be used in advertising or publicity pertaining to distribution of the software without specific, written prior permission. The Institute of Software, Academia Sinica, makes no representations about the suitability of this software for any purpose. It is provided "as is" without express or implied warranty.

THE INSTITUTE OF SOFTWARE, ACADEMIA SINICA, DISCLAIMS ALL WARRANTIES WITH REGARD TO THIS SOFTWARE, INCLUDING ALL IMPLIED WARRANTIES OF MERCHANTABILITY AND FITNESS, IN NO EVENT SHALL THE INSTITUTE OF SOFTWARE, ACADEMIA SINICA, BE LIABLE FOR ANY SPECIAL, INDIRECT OR CONSEQUENTIAL DAMAGES OR ANY DAMAGES WHATSOEVER RESULTING FROM LOSS OF USE, DATA OR PROFITS, WHETHER IN AN ACTION OF CONTRACT, NEGLIGENCE OR OTHER TORTIOUS ACTION, ARISING OUT OF OR IN CONNECTION WITH THE USE OR PERFORMANCE OF THIS SOFTWARE.

© Copyright 1986-2000, Hwan Design Inc.

You are hereby granted permission under all Hwan Design propriety rights to use, copy, modify, sublicense, sell, and redistribute the 4 Baekmuk truetype outline fonts for any purpose and without restriction; provided, that this notice is left intact on all copies of such fonts and that Hwan Design Int.'s trademark is acknowledged as shown below on all copies of the 4 Baekmuk truetype fonts.

BAEKMUK BATANG is a registered trademark of Hwan Design Inc.  
BAEKMUK GULIM is a registered trademark of Hwan Design Inc. BAEKMUK DOTUM is a registered trademark of Hwan Design Inc. BAEKMUK HEADLINE is a registered trademark of Hwan Design Inc.

© Copyright 2000-2001 /efont/ The Electronic Font Open Laboratory. All rights reserved.

Redistribution and use in source and binary forms, with or without modification, are permitted provided that the following conditions are met:

- Redistribution of source code must retain the above copyright notice, this list of conditions and the following disclaimer.
- Redistributions in binary form must reproduce the above copyright notice, this list of conditions and the following disclaimer in the documentation and/or other materials provided with the distribution.
- Neither the name of the team nor the names of its contributors may be used to endorse or promote products derived from this font without specific prior written permission.

THIS FONT IS PROVIDED BY THE TEAM AND CONTRIBUTORS "AS IS" AND ANY EXPRESS OR IMPLIED WARRANTIES, INCLUDING, BUT NOT LIMITED TO, THE IMPLIED WARRANTIES OF MERCHANTABILITY AND FITNESS FOR A PARTICULAR PURPOSE ARE DISCLAIMED. IN NO EVENT SHALL THE TEAM OR CONTRIBUTORS BE LIABLE FOR ANY DIRECT, INDIRECT, INCIDENTAL, SPECIAL, EXEMPLARY, OR CONSEQUENTIAL DAMAGES (INCLUDING, BUT NOT LIMITED TO, PROCUREMENT OF SUBSTITUTE GOODS OR SERVICES; LOSS OF USE, DATA, OR PROFITS; OR BUSINESS INTERRUPTION) HOWEVER CAUSED AND ON ANY THEORY OF LIABILITY, WHETHER IN CONTRACT, STRICT LIABILITY, OR TORT (INCLUDING NEGLIGENCE OR OTHERWISE) ARISING IN ANY WAY OUT OF THE USE OF THIS FONT, EVEN IF ADVISED OF THE POSSIBILITY OF SUCH DAMAGE.

# Index

## Symbols and Numbers

1, 2, 3, or 4

channel connectors, 18

channel menu buttons, 14

## A

Abort printing, 74, 90

AC coupling

trigger, 96

vertical, 104

Accessories, 123

Acquire button, 17, 75

Acquire menu, 75

Acquire signals

basic concepts, 22

Acquisition

live display, 77

single-shot example, 41

stopping, 77

Acquisition modes, 22, 75

Average, 22, 76

indicators, 10

Peak Detect, 22, 76

Sample, 22, 75

Add waveforms

Math menu, 87

Aliasing

check for, 24

FFT, 59

time domain, 23

Amplitude cursors, 26, 82

Amplitude measurements

using cursors, 36

Application examples

analyzing a differential

communication

signal, 49

analyzing signal detail, 40

automatic measurements, 30

autoranging to examine test

points, 35

autoset, using, 30

averaging, using, 40

calculating amplifier gain, 34

capturing a single-shot

signal, 41

cursors, using, 36

data logging, 52

limit testing, 53

looking at a noisy signal, 40

measuring propagation

delay, 43

measuring pulse width, 37

measuring ring amplitude, 36

measuring ring frequency, 36

measuring rise time, 38

measuring two signals, 33

optimizing the acquisition, 42

peak detect, using, 40

reducing noise, 40

taking automatic

measurements, 31

taking cursor

measurements, 36

triggering on a specific pulse

width, 44

triggering on a video

signal, 45

triggering on video fields, 46

triggering on video lines, 47

using Autorange to examine

test points, 35

using persistence, 52

using the window

function, 48

using XY mode, 51

viewing impedance changes

in a network, 50

Attenuation

voltage probe, 5, 7, 105

Attenuation switch, 8

Auto trigger mode, 96

Automatic measurements, 89

basic concepts, 26

AutoRange button, 17

Autorange functions, 19

overview, 77

turning off, 78

Autorange menu, 77

AutoSet

button, 17

Autoset functions, 19

DC level, 79

FFT, 81

noise, 80

overview, 79

pulse signal, 81

sine waves, 80

square wave, 81

Undo, 81

video signal, 81

when to use, 80

Autoset menu, 79

Average

acquisition mode, 75

Mean measurement, 89

Average acquisition mode, 22, 76

Average mode

icon, 10

## B

Bandwidth limit

trigger, 96

vertical, 105

Bandwidth limited

readout, 11

Bezel buttons, xvi

BMP file format, 68

Button names, xvi

BW limit for vertical, 105

## C

Calendar, 102

Calibration, 102

automatic routine, 8

- Channel
  - coupling, 104
  - menu, 104
  - scale, 11
- Cleaning, 125
- Clock
  - set date and time, 102
- Coarse resolution, 105
- Communication
  - OpenChoice software installation, 70
- Compensation
  - PROBE COMP connector, 18
  - voltage probe check wizard, 5
  - voltage probe manual, 7
- Connectors
  - Channels 1, 2, 3 and 4, 18
  - Ext Trig, 18
  - PROBE COMP, 18
  - USB Device port, 69
  - USB Flash Drive port, 63
- Context-sensitive help topics, xiv
- Conventions used in this manual, xvi
- Cooling by convection, 3
- Coupling
  - trigger, 21, 97
  - vertical, 104, 105
- CSV file format, 94
- Current folder, 64, 103
- Current probes
  - scale setting, 8, 105
- Cursor button, 17, 82
- Cursor menu, 82
- Cursor RMS measurements, 89
- Cursors
  - adjusting, 82
  - Amplitude, 26, 82
  - basic concepts, 26
  - Frequency for FFT, 82
  - Magnitude for FFT, 82
  - measurement examples, 36
  - measuring an FFT spectrum, 62
  - Time, 26, 82
  - using, 82
- Cycle RMS measurements, 89
- D**
  - Data logging
    - application example, 52
  - Date, 102
  - Date and time readout, 12
  - DC coupling
    - trigger, 96
    - vertical, 104
  - Default setup
    - Edge trigger, 127, 128
    - Pulse trigger, 128
    - recalling, 95
    - Video trigger, 128
  - Default Setup button
    - option and control settings, 127
    - retained option settings, 128
  - Delay measurements, 89
  - Delayed sweep, 86
  - Deleting
    - files or folders, 103
  - Deleting files or folders, 100
  - Delta readouts in Cursor menu, 82
  - Description
    - general, 1
  - Diagonal lines in waveform
    - peak detect, 76
  - Directories
    - deleting, 100, 103
  - Display
    - intensity, 83
    - menu, 83
    - persistence, 83
    - readouts, 9
    - style (Invert), 105
    - style of waveforms, 83
    - type: vectors or dots, 83
    - XY format, 83
    - YT format, 83
  - Display button, 17, 83
  - Displaying waveforms, 104
    - reference, 91
  - Do Self Cal option, 8
  - Dots display type, 83
  - Dual time base, 14, 86
  - Duty cycle measurements, 89
- E**
  - Edge trigger, 96
  - EPSIMAGE file format, 68
  - Error Log, 102
  - Ext Trig connector, 18
    - probe compensation, 6
- F**
  - Factory calibration, 103
  - Factory setup, 127
    - recalling, 95
  - Fall time measurements, 89
  - Features
    - overview, 1
  - FFT aliasing, 59
    - remedies, 61
  - FFT spectrum
    - applications, 55
    - displaying, 57
    - magnify, 61
    - measuring magnitude and frequency with cursors, 62
    - Nyquist frequency, 56
    - process, 55
    - readouts, 57
    - window, 58
  - FFT window
    - Flattop, 59
    - Hanning, 59
    - Rectangular, 59
  - FFT zoom
    - horizontal, 57
    - vertical, 56
  - Field video trigger, 98
  - File formats for images, 68
  - File utilities, 103
    - creating files or folders, 103
    - deleting files or folders, 100, 103
    - navigating the directory structure, 103
    - renaming files or folders, 104
    - selecting files or folders, 103
    - USB flash drive contents, 103
  - Fine resolution, 105

- Firmware update
  - Internet, xv
- Firmware updates, 104
- Flattop window, 59
- Folders
  - creating, 103
  - deleting, 100, 103
  - renaming, 104
- Force Trig button, 15
- Format
  - display, 83
  - image file, 68
  - USB flash drive, 64
- Frequency
  - trigger readout, 12, 96
- Frequency cursors, 26
  - FFT spectrum, 62
- Frequency measurements, 89
  - FFT cursors, 62
  - using cursors, 36
- Functional check, 4

## G

- GPIB adapter
  - ordering, 124
- GPIB system
  - connecting to an
    - oscilloscope, 72
- Graticule, 26, 83
- Ground coupling, 104

## H

- Hanning window, 59
- Help scroll LED, xiv
- Help system, xiv
- Helpful messages, 12
- Holdoff, 87, 101
- Holdoff control, 15
- Horiz Menu button, 14

- Horizontal
  - aliasing, time domain, 23
  - menu, 86
  - position, 23
  - position marker, 11
  - scale, 23
  - Scan mode, 77, 87
  - status, 102
- Horizontal scale control, 14
- Horizontal Scale control, 87
- Hyperlinks in help topics, xiv

## I

- Icons
  - acquisition modes,
    - Average, 10
  - acquisition modes, Peak
    - Detect, 10
  - acquisition modes,
    - Sample, 10
  - bandwidth limited readout, 11
  - channel scale, 11
  - date and time readout, 12
  - horizontal position
    - marker, 11
  - inverted waveform
    - readout, 11
  - reference marker, 11
  - reference waveforms
    - readout, 12
  - time base readout, 11
  - trigger position marker, 11
  - trigger status, Acq.
    - Complete, 11
  - trigger status, Armed, 11
  - trigger status, Auto mode, 11
  - trigger status, Ready, 11
  - trigger status, Scan mode, 11
  - trigger status, Stop, 11
  - trigger status, Trig'd, 11
  - trigger type, Edge, 11
  - trigger type, Pulse Width, 11
  - trigger type, Video, 11
  - trigger, frequency readout, 12
  - trigger, level marker, 11
  - trigger, level readout, 12
  - trigger, position readout, 11
  - trigger, source, 11
  - vertical scale, 11
  - window time base readout, 11
- Image file formats, 68
- Index for help topics, xiv
- Indicators, 10
- Infrequent events
  - infinite persistence, 84
- Installation
  - OpenChoice software on a
    - PC, 70
- Intensity, 83

Interpolation, 76  
Inverted waveform  
    readout, 11

## J

JPG file format, 68

## L

Languages, 102  
Level, 15, 21  
Level control, 15  
Limit testing  
    application example, 53  
Line video trigger, 98  
Lissajous pattern  
    XY format, 84

## M

M indicator for Main time  
    base, 86  
Magnify horizontal  
    window, 86  
Magnitude cursors, 26  
    FFT spectrum, 62  
Main time base, 14, 86  
Manuals ordering, 124  
Math  
    FFT, 55, 57  
    functions, 87  
    menu, 87  
Math Menu button, 14  
math waveform  
    allowed units, 88  
Maximum measurements, 89  
Measure button, 17  
Measure menu, 89

Measurements  
    automatic, 26, 89  
    basic concepts, 25  
    cursor, 26, 36  
    cursor RMS, 89  
    cycle RMS, 89  
    delay, 89  
    duty cycle, 89  
    fall time, 89  
    FFT spectrum, 62  
    frequency, 89  
    graticule, 26  
    maximum, 89  
    mean, 89  
    minimum, 89  
    negative width, 89  
    peak-to-peak, 89  
    period, 89  
    phase, 89  
    positive width, 89  
    rise time, 89  
    RMS, 89  
    types, 89

Memory  
    screen images, 91  
    setups, 91  
    USB flash drive, 63  
    waveforms, 91

Menu system  
    using, 12

Menus  
    Acquire, 75  
    Autorange, 77  
    Autoset, 79  
    Cursor, 82  
    Display, 83  
    Help, 86  
    Horizontal, 86  
    Math, 87  
    Math FFT, 57  
    Measure, 89  
    Print, 90  
    Ref, 91  
    Save/Recall, 91  
    Trigger, 96  
    Utility, 101  
    Vertical, 104

Messages, 12  
Minimum measurements, 89  
Multiply waveforms  
    Math menu, 87  
Multipurpose knob, 16

## N

Navigation  
    file system, 103  
Negative width measurements, 89  
Noise reduction  
    Average mode, 75  
    Math subtraction, 88  
    trigger coupling, 96  
    vertical bandwidth limit, 105  
Nonvolatile memory  
    reference waveform files, 92  
    setup files, 92  
Normal operation  
    recall default setup, 20  
Normal trigger mode, 96  
NTSC video standard, 98  
Nyquist  
    frequency, 56

## O

OpenChoice software, 123  
    installation, 70  
Option buttons, xvi  
Option types  
    action, 13  
    circular list, 12  
    page selection, 12  
    radio, 13  
Oscilloscope  
    connecting to a GPIB  
        system, 72  
    connecting to a PC, 70  
    connecting to a printer, 73  
    front panels, 9  
    set date and time, 102  
    specifications, 107  
    understanding functions, 19

## P

PAL video standard, 98

- Panning
    - horizontal, 23
    - vertical, 23
  - PC
    - connecting to an oscilloscope, 70
  - PCX file format, 68
  - Peak Detect acquisition mode, 22, 76
  - Peak Detect mode, 75
    - icon, 10
  - Peak-to-Peak measurements, 89
  - Peak-to-peak noise, 84
  - Period measurements, 89
  - Persistence, 83, 84
  - Phase differences, 84
  - Phase measurements, 89
  - Polarity
    - Pulse Width trigger, 99
    - Video trigger sync, 98
  - Ports
    - USB flash drive, 63
  - Position
    - horizontal, 23, 86
    - trigger, 98
    - vertical, 104
  - Position control
    - horizontal, 14
    - vertical, 14
  - Positive width measurements, 89
  - Power, 2
    - specifications, 113
  - Power cords, 2
    - ordering, 124
  - Power Cycle count, 102
  - Pretrigger, 20
  - Pretrigger view, 98
  - Print button, 17
  - PRINT button option, 92
  - PRINT Button option, 90
    - saving to a USB flash drive, 67
  - Printer
    - connecting, 73
    - PictBridge compatible, 73
    - setup, 73
  - Printing
    - abort, 74, 90
    - screen data, 90
    - screen image, 73
  - PROBE CHECK button, 6
  - Probe Check Wizard
    - voltage probes, 5
  - PROBE COMP connections, 18
  - Probe option
    - match current probe scale, 8
    - match voltage probe attenuation, 7
  - Probes
    - Attenuation switch, 7
    - compensation, 18
    - current and scale, 8
    - safety, 5
    - voltage and attenuation, 105
    - voltage probe check wizard, 5
    - voltage probe manual compensation, 7
  - Programmer manual
    - ordering, 124
  - Pulse signal
    - Autoset function, 81
  - Pulse width measurements
    - using cursors, 37
  - Pulse Width triggering, 99
- ## R
- Readouts
    - FFT (Math), 57
    - general, 9
  - Recall
    - factory setup (default), 20
    - setups, 20, 95
    - waveforms, 95
  - Recall Setup menu, 94
  - Recall Waveform menu, 95
  - Rectangular window, 59
  - Ref button, 17
  - Ref menu, 91
  - Reference
    - lead for probe, 5
    - marker, 11
    - probe terminal, 5
    - terminal, 18
  - Reference waveforms
    - displaying and removing, 91
    - readout, 12
    - saving and recalling, 95
  - Remote control using a GPIB interface, 72
  - Removable file storage
    - USB flash drive, 63
  - Removing reference waveforms, 91
  - Removing waveforms, 104
  - Renaming files or folders, 104
  - Resolution
    - fine, 105
  - Rise time measurements
    - automatic, 89
    - using cursors, 38
  - RLE file format, 68
  - RMS measurements, 89
  - Roll mode *See* Scan mode
  - Run/Stop button, 17, 76
    - steps taken by the oscilloscope when pushed, 20
- ## S
- Safety Summary, iv
  - Sample acquisition mode, 22, 75
  - Sample mode
    - icon, 10
  - Sample rate
    - maximum, 75
  - Save
    - setups, 20
  - Save All menu, 92
  - Save Image menu, 92
  - Save Setup menu, 93
  - Save to a USB flash drive, 63
  - Save Waveform menu, 94
  - Save/Recall button, 17
  - Save/Recall menu, 91
    - saving to a USB flash drive, 65

- Saving
    - all files to a USB flash drive, 67
    - image files to a USB flash drive, 68
    - setups, 95
    - waveforms, 95
  - Scale
    - control, 14
    - Course, 105
    - current probe, 8, 105
    - Fine, 105
    - horizontal, 23
    - vertical, 23
  - Scaling waveforms
    - basic concepts, 23
  - Scan mode, 77, 87
  - Scanning waveforms, 87
  - Screen buttons, xvi
  - Screen image
    - saving to a file, 68
    - sending to a printer, 73
  - SECAM video standard, 98
  - Security loop, 2
  - Self calibration, 8
  - Service
    - error log as a reference, 102
  - Service manual ordering, 124
  - Set date and time, 102
  - Set To 50% button, 15
  - Set To Zero button, 14
  - Setups
    - basic concepts, 19
    - saving and recalling, 91
  - Side-menu buttons, xvi
  - Sine waves
    - Autoset function, 80
  - Single button, 77
    - steps taken by the oscilloscope when pushed, 20
  - Single-shot signal
    - application example, 41
  - Slope, 21
  - Soft case ordering, 124
  - Soft keys, xvi
  - Software
    - OpenChoice, 123
  - Source
    - AC Line, 98
    - Ext, 97
    - Ext/5, 97
    - trigger, 21, 96, 98, 99
  - Specifications
    - oscilloscope, 107
  - Square wave
    - Autoset function, 81
  - Status
    - miscellaneous, 102
    - system, 101
  - Subtract waveforms
    - Math menu, 87
  - Sweep
    - delayed, 86
    - horizontal scale, 86
  - Sync
    - video polarity, 98
    - video trigger line or field, 98
  - Sync pulse, 98
- T**
- TEK-USB-488 adapter
    - connecting, 72
    - ordering, 124
  - TIFF file format, 68
  - Time base, 22
    - Main, 14, 86
    - readout, 11
    - Window, 14, 86
  - Time cursors, 26, 82
  - Time domain
    - waveform, 55
  - Time-out trigger, 112
  - Transit case ordering, 124
  - Trig Menu button, 15
  - Trig View button, 15
- U**
- USB Device port, 69
  - USB flash drive
    - file management, 64
    - File utilities, 103
    - formatting, 64
    - installation, 63
    - port location, 18
    - Print button, 67
    - Save operation indicator, 63
    - Save/Recall menu, 65
    - saving files, all, 67
    - saving files, images, 68
    - saving files, setups, 67
    - saving files, waveforms, 67
    - storage capacity, 64
  - USB Flash Drive port, 63
  - Utility button, 17



Utility menus, 101

## V

Vectors, 83

Ventilation, 3

Vertical

    menu, 104

    position, 23

    position knob, 14

    scale, 23

    status, 102

Video signal

    Autoset function, 81

Video trigger, 98

    application example, 45

Volts/Div

    Coarse, 105

    Fine, 105

Volts/division

    control, 14

## W

W indicator for Window time  
    base, 86

Waveforms

    acquire data, 22

    compression, 87

    digitized, 22

    display style meaning, 83

    expansion, 87

    position, 23

    remove from screen, 105

    scale, 23

    scanning, 77

    take measurements, 25

    time domain, 55

Window time base, 14, 86

    readout, 11

Window zone, 86

Window Zone, 87

Windows

    FFT spectrum, 58

## X

XY

    application example, 51

    display format, 83, 84

## Y

YT

    display format, 83

## Z

Zoom, 48

    FFT, 61

    Horiz menu, 86

    window zone, 86, 87